

Total Energy Controls



TEC Energy Master Installation
& Programming Manual

Contents

Description	Page
Installation Instructions	
General Notes	3
Fixing the Enclosure	3
Mains Wiring	4
Control Wiring	4
Fitting and Wiring Temperature Sensors	6
Temperature Display Calibration	8
Commissioning Instructions	
Introduction	9
Keypad Overview	9
Establishing the System Max Flow Temp	11
Setting the Programs	12
Setting the Calendar	12
Programming the On / Off Times	14
Frequency (How the Time Clock works)	16
Select Days	17
Setting the Maximum Heating Temperature	18
Setting the Maximum Hot Water Temperature	18
Setting the Minimum Flow Temperature	20
Setting the Minimum Return/HW Temperature	21
Setting the Night Temperature	22
Setting the Frost Temperature	23
Setting the External Cut-Off Temperature	24
Setting the External Cut-Off Mode	24
Calibration	25
Hot Water Boost	27
Hot Water 24 Hours Priority	27
Exiting Programming Mode	28

Installation

General Notes

The installation of all TEC units should be carried out by a qualified electrical engineer familiar with heating systems and control wiring.

All control circuits of TEC units are 'volt free' and may be used to switch 240V AC or low voltage control systems.

Extreme care must be taken to ensure that all wiring is correct before applying power, as irreparable damage to the PCB could result due to incorrect connections.

Fixing the Enclosure

Select a suitable position for the Energy Master adjacent to the boiler, away from any high heat source, i.e. flue etc.

Fasten the rear enclosure to the wall and drill cable entry holes as required to accept cables (heat resistant) either via 12mm (max) self adhesive plastic trunking or other suitable means. Strip off 15-20cm of outer insulation on all cables to give flexibility and to avoid tension on the PCB terminals.

Once all cables have been installed as described in the following sections, fit the front enclosure with the supplied screws and attach the 4 blanking plugs.

Mains Wiring

A 240V AC 1Ph 50Hz supply may be taken from the existing time clock switched or permanent supply, or direct from the boiler mains input connections (where available), which ever is the most suitable. The 240V connection for the Energy Master is shown in Fig.1 below.

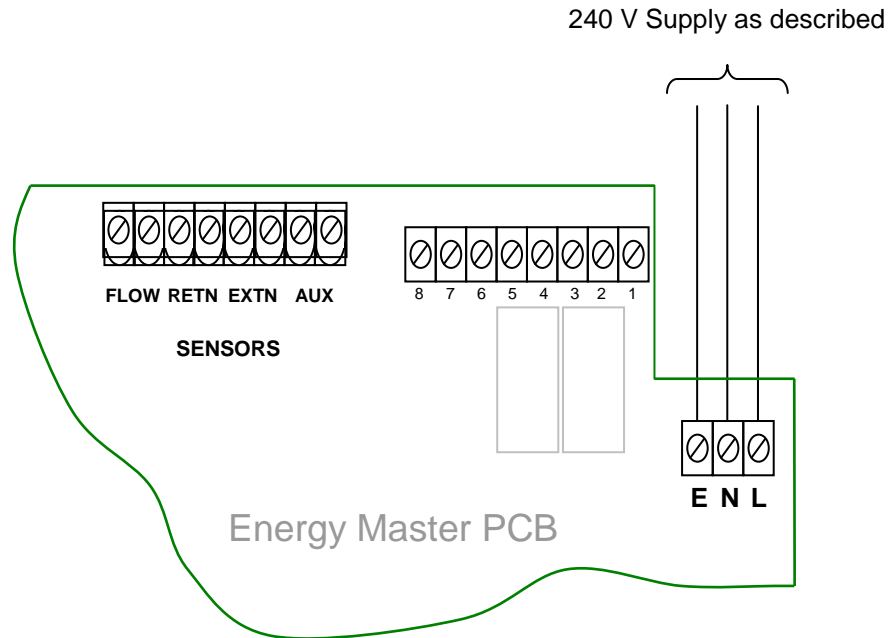

Fig. 1

Control Wiring

Many boilers are provided with an accessible mains terminal block. Most have a pair of connections (usually unused) for use with external controls. These connections will have a link which needs to be removed so that the Energy Master control wires can be connected as shown in Fig.2.

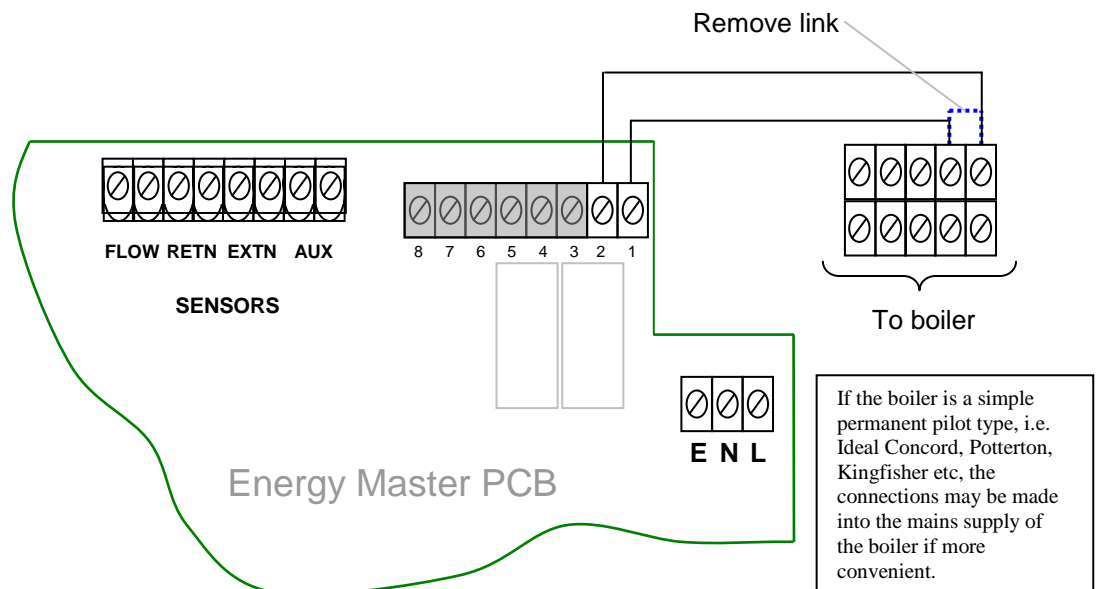

Fig. 2

Note: A 5-core heat resistant flex is ideal for connecting the Energy Master to the boiler. The recommended connection method is via 12mm self adhesive conduit to house the cable. A separate 2-core cable will be required should the pump control circuit be used.

Where a terminal block arrangement as shown in Fig.2 is not available, the control wiring should be connected directly into the boiler thermostat wiring as shown in Fig.3.

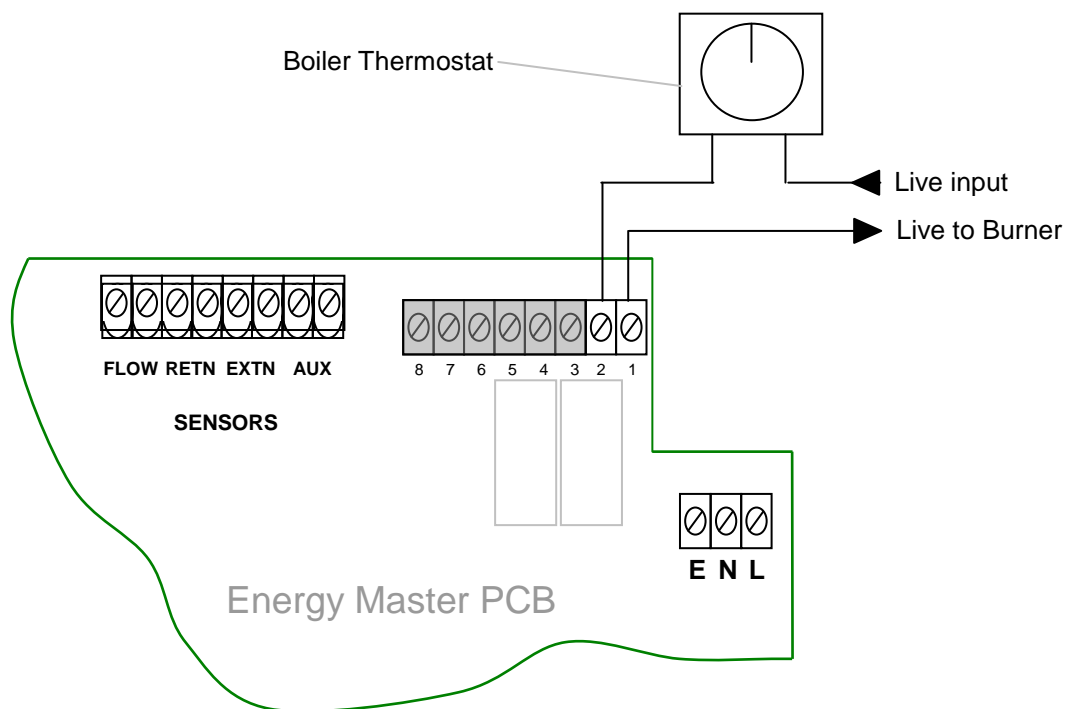

Fig. 3

The left hand relay on the Energy Master is the **Pump Relay** which may be used to control a circulating pump. Connections are as shown in Fig.4 on the next page.

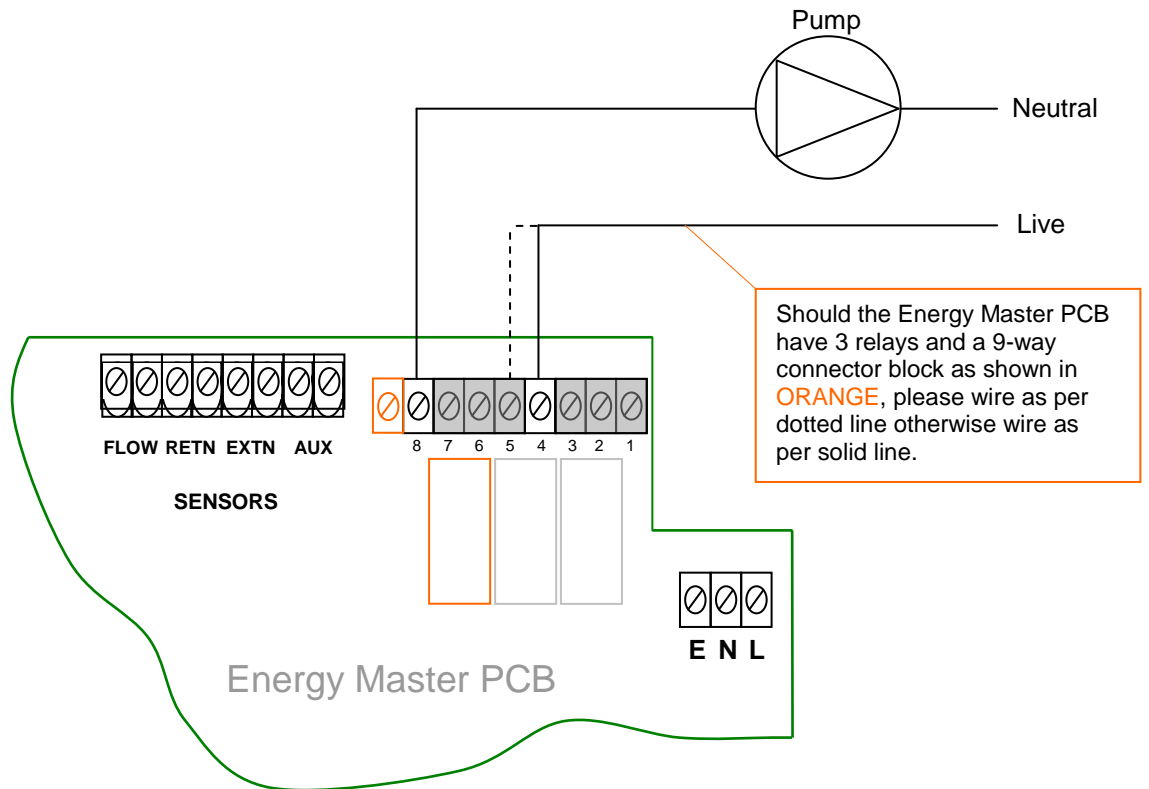

Fig. 4

Fitting and Wiring Temperature Sensors

The Energy Master has three temperature sensor inputs, these being **Flow**, **Return/Hot Water** and **External**. Connections are as shown in Fig.5.

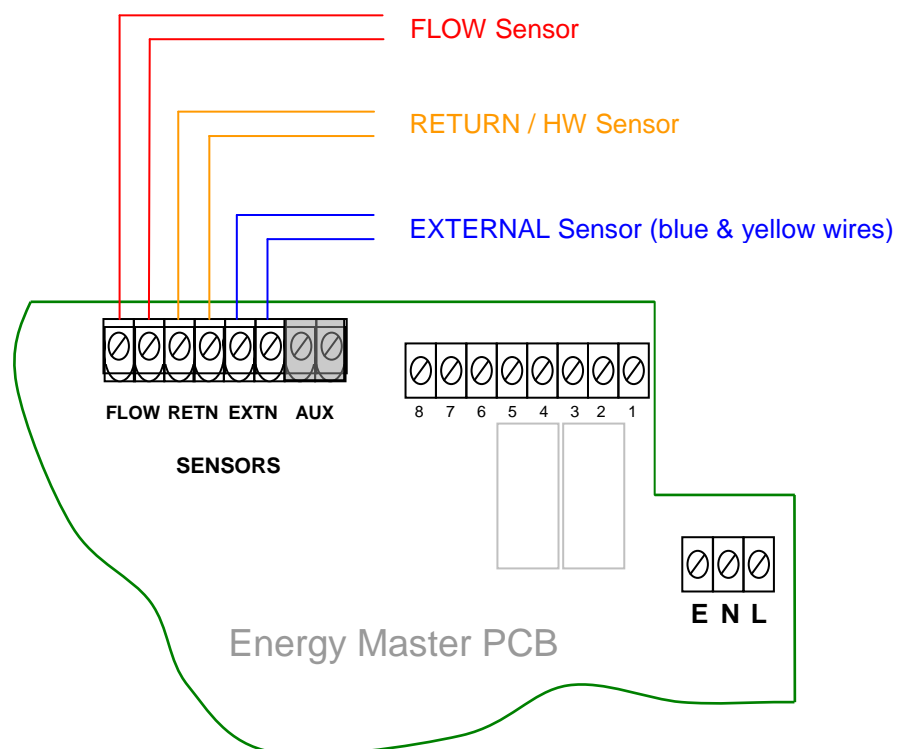

Fig. 5

Flow / Return Temperature Sensors (Cable Type)

Using **heat resistant** cloth tape, **tightly** strap the sensors to the relevant **flow** and **return** pipes, **close** to boiler, **before** any branching connections. Cover the sensors with heating pipe insulation and strap with ty-wraps or similar. See Fig.6.

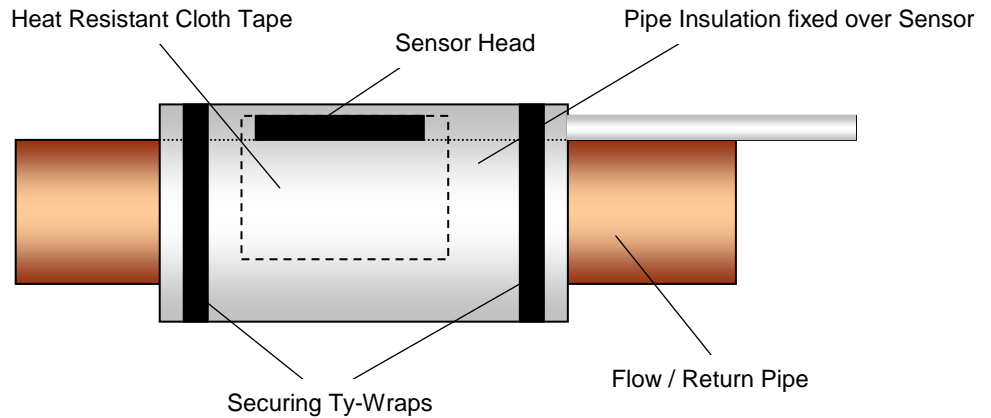

Fig. 6

Optional Hot Water Tank Sensor connections (replaces Return Temperature Sensor) are shown in Fig.7.

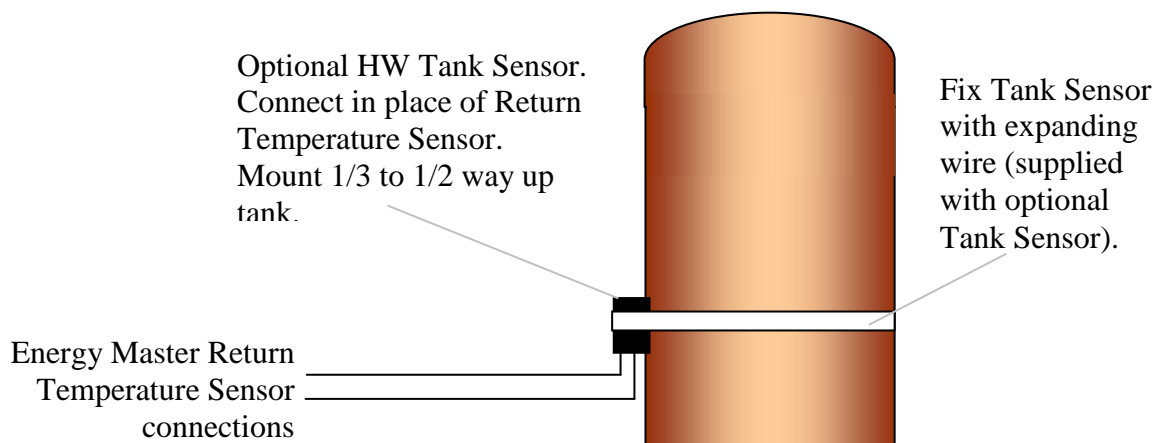

Fig. 7

If the hot water tank is a distance from the boiler, wiring to it may be impractical.

If hot water priority is important then the **Return Sensor** should be fitted to the **Hot Water Tank Return Pipe**. If this is also impractical, then fit as normal to the main **Return Pipe** and set the **Minimum Return Temperature** to provide an adequate level of hot water supply.

Where the tank option is used, set the **Minimum Return Temperature** to the stored water temperature requirement.

External Sensor

The **External Sensor** should preferably be positioned on a north facing exterior wall, and connected to the appropriate terminals of the Energy Master using the blue and yellow wires of the 4-core cable provided. On long cable runs the remaining cores should be earthed to prevent interference.

If it is not possible to mount the sensor on a north facing wall, then mount in a shaded position, under eaves, and away from boiler house vent grilles etc.

Temperature Display Calibration

When required, the temperatures as displayed on the Energy Master may be adjusted to cater for heat losses on pipework, losses on external temperature sensor etc. Program 11 (see page 25) can be used to calibrate the temperature display by $-10^{\circ}\text{C}/+20^{\circ}\text{C}$.

Commissioning - Introduction

The Energy Master Digital has 12 main programs, these being:

- | | | |
|-----|-------------------------------|----------------------------------|
| 1. | Calendar | |
| 2. | On/Off Times | (Two On/Off Periods per day) |
| 3. | Frequency | (Once, Twice, 24 Hours) |
| 4. | Select Days | (Every Day, Weekends, Week Days) |
| 5. | Maximum Heating Temperature | (30°C to 85°C) |
| | Maximum Hot Water Temperature | (30°C to 85°C)** |
| 6. | Minimum Heating Temperature | (25°C to 85°C) |
| 7. | Minimum Return/HW Temperature | (20°C to 65°C) |
| 8. | Night Temperature | (0°C to 85°C) |
| 9. | Frost Temperature | (0°C to 35°C) |
| 10. | External Cut Off Temperature | (0°C to 35°C) |
| 11. | Calibration (Engineers Only) | (-10°C/+20°C) |
| 12. | HW Boost / HW 24 Hours | (Yes / No) |

** This is NOT the hot water storage temperature.

Keypad and Running Mode Overview



PROGRAM

Used to enter Programming Mode from normal running mode, and to access Change Mode for the selected program.



SELECT

Used to cycle through the program list when in Programming Mode and to change program settings when in Change Mode.

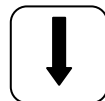

RETURN

Used to cycle through the program list when in Programming Mode and to change program settings when in Change Mode.



ENTER

Used to confirm a programming change and to exit from the Programming Mode.

Firing mode indicates that the boiler is firing.

```

FIRING Tu 10:05
S57 F50 R42 E12

```

Temp Set indicates that the **actual Flow Temp** is above the **system set temperature**. The boiler will **not** be firing at this point.

```

TEMP SET Tu 10:05
S57 F59 R53 E12

```

Economising indicate that the Energy Master has entered self learning mode and is making economies. The boiler will **not** be firing at this point.

```

ECO Tu 10:05
S57 F59 R53 E12

```

E 'flashing' indicates that the external temp is above the level set in the **Ext Cut-Off** program.

```

TEMP SET Tu 10:05
S57 F36 R34 E16

```

Establishing the System Maximum Flow Temp

Switch on the power to the Energy Master.

1. Set the **Active/Bypass** switch to the **Bypass** position.
Allow the heating system to cycle twice at the normal winter setting of the boiler thermostat (see customer, plant engineer, caretaker etc to establish winter thermostat position).

2. The display will show:

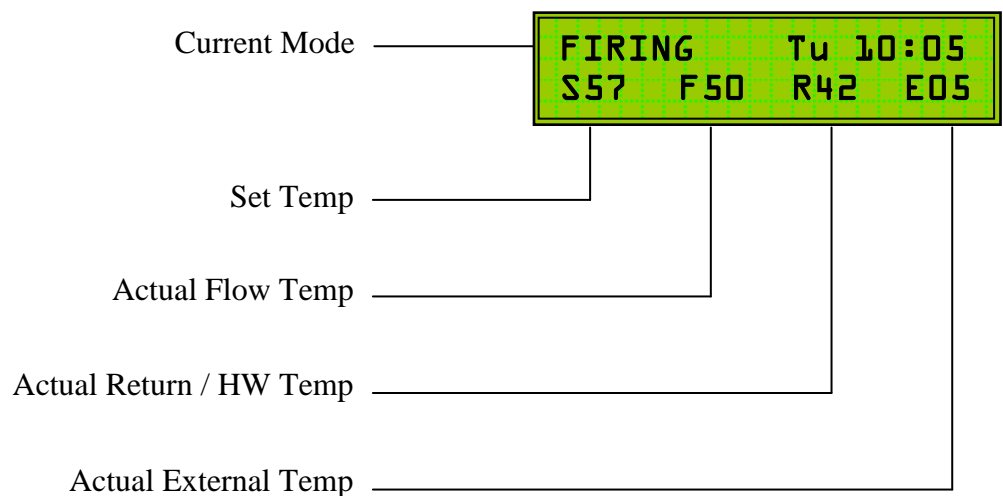

3. When the actual **Flow Temperature** exceeds the **Set Temperature**, the display will change:

TEMP-SET Tu 10:05
S57 F58 R48 E05

4. When the boiler has cycled twice with the Energy Master in **constant mode**, observe the **actual flow temperature** as shown on the display:











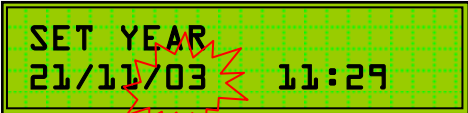

TEMP-SET Tu 10:05
S57 F73 R65 E05

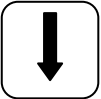

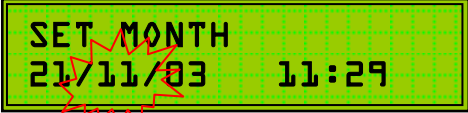

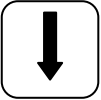

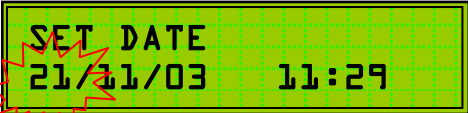

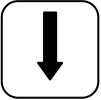

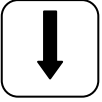

In this example, the winter setting for the heating system (Energy Master maximum flow setting) should be set to 72°C (73°C - 1°C).

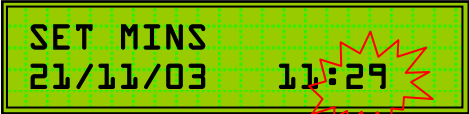
The Boiler Thermostat should now be set to a slightly higher setting to ensure correct operation of the Energy Master and to allow the Maximum HW Temp (P5a) to function.

Setting the Programs

P1. Setting the Calendar (Factory Set)

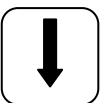
1. Press  to change display to: 
2. Press  again to display: 
3. Press  or  to set the year.
4. Press  to change display to: 
5. Press  or  to set the month.
6. Press  to change display to: 
7. Press  or  to set the date.

8. Press  to change display to: 
9. Press  or  to set the hour.
8. Press  to change display to: 
9. Press  or  to set the minutes.
10. Press  to change display to: 
11. Press  or  to set the day.
12. Press  to confirm the program change and return to main menu.
13. Press  to advance to next program.
-

P2. Programming the Time Clock (On/Off Times)

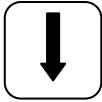
1. Press  or  to select program 2:

2 ON/OFF TIMES

2. Press  again to display:

M0 1 07:30-00:00
2 00:00-16:30

There are two (2) programmable On/Off times per day.

The second OFF time must ALWAYS be programmed, and set to a time after, but in the same 24 hour period as the first ON time.

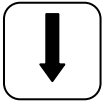
3. To change On/Off Times select the required day with  

4. Press  to enter programming mode for the chosen day:

M0 1 07:30-00:00
* 2 00:00-16:30

5. Press  to set first ON time:

M0 1 07:30-00:00
* 2 00:00-16:30

6. Press  or  to set the hour as required.

7. Press  to set first ON time minutes:

M0 1 07:30-00:00
* 2 00:00-16:30

8. Press  or  to set the minutes as required.

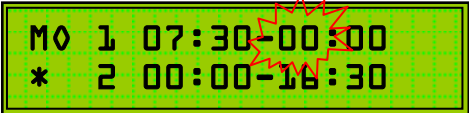
9. Press  to set first OFF** time: 

** If the FIRST OFF time is not required leave at 00:00.

Adjust HOUR and MINUTES in the same way as previously described.

10. Press  to set the second ON time and repeat as above.

11. Press  to set the second OFF time and repeat as above.

If different On/Off times are required for each day, then repeat the above instructions for each day's times.

To repeat a days On/Off times into the next day, select the next day as

described above and press  followed by .

12. Press  to confirm program changes and return to main menu.

P3. Frequency (How the Time Clock operates)

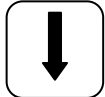
1. Press  or  to select program 3:
 SELECT RETURN

3 FREQUENCY
CURRENT ONCE

2. Press  to display:
 PROGRAM

UP/DN TO CHANGE
CURRENT ONCE

3. Press  or  to set as described below:
 SELECT RETURN

ONCE The time clock operates from the first ON time to the second OFF time.

TWICE The time clock operates on both ON and OFF times i.e. two On/Off periods per day.

24 HOUR The time clock operates 24 hours a day regardless of the On/Off settings.

4. Press  to confirm program changes and return to main menu.
 ENTER
-

P4. Select Days

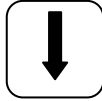
1. Press  or  to select program 4:
SELECT **RETURN**

4 SELECT DAYS
CURRENT EVERY DAY

2. Press  to display:
PROGRAM

UP/DN TO CHANGE
CURRENT ~~EVERY DAY~~

3. Press  or  to set as described below:
SELECT **RETURN**

EVERY DAY

The heating will operate everyday as set by the time clock On/Off times.

WEEK ENDS

The heating will operate at week ends only as set by time clock On/Off time for Sat – Sun. If reduced heating is required at week ends then set the time clock for reduced hours during Saturday and Sunday, and then set program 4 to EVERY DAY.

WEEK DAYS

The heating will operate during week days only as set by the time clock On/Off times Mon – Fri. The heating will be OFF at weekends.





















4. Press  to confirm program changes and return to main menu.
ENTER
-





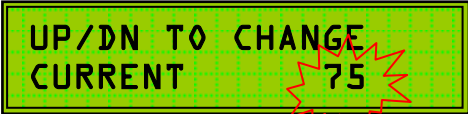

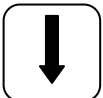

P5. Setting the Max Heating and Hot Water Temperature

Program 5 allows for the setting of two maximum flow temperatures:

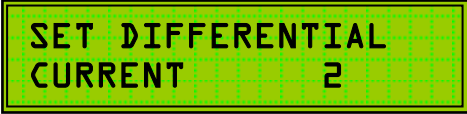



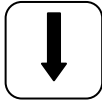







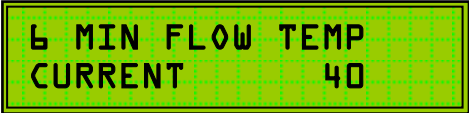

MAX HTG TEMP – The maximum flow temperature required for central heating.

MAX HW TEMP - The maximum flow temperature required for hot water recovery as dictated by program 7.

1. Press  or  to select program 5:
 or 

2. Press  to change display to:

3. Press  or  to change the temperature setting to that required (i.e. 73°C).
 or 
4. Press  to confirm the program and change display to:

5. Press  to change display to:

6. Press  or  to change the temperature setting to that required (i.e. 75°C).
 or 

7. Press  to confirm the program and change display to:
-  
8. Press  to change display to:
-  
9. Press  or  to change the differential setting to that required (normally 3 - 4 °C).
-  
-

P6. Setting the Minimum Flow Temperature

1. Press  or  to select program 6:
 or 

2. Press  to change display to:

3. Press  or  to change the temperature setting to that required.
 or 
4. Press  to confirm the program changes and return to main menu.

Setting a Minimum Flow Temperature is required to limit the effect of the Compensation. The flow temperature will not fall below that set in the Minimum Flow program (- differential), even if the compensated flow temperature is below this level.

The Minimum Flow Temperature should be chosen to meet heating criteria.

P7. Setting the Minimum Return/HW Temperature

The **Minimum Return/HW** temperature will depend on the type of heating system:

Heating and Hot Water.

Where convenient, the return temperature sensor should be fitted to the hot water storage tank (see installation instructions), the hot water return pipework or the hot water circulating pipework.



The **minimum return temperature** should be set to provide normal hot water tank temperature, i.e. 60°C.

Heating Only.

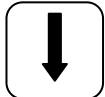
In this instance, the **minimum return temperature** should be set to the boiler manufacturers recommended level, i.e. 55°C for oil fired systems, 50°C or lower for gas fired systems. These figures are examples only. Refer to your boiler manual for manufacturer recommended settings.

1. Press  **SELECT** or  **RETURN** to select program 7:

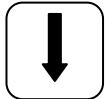

7 MIN RETN/HW TEMP
CURRENT 50
2. Press  **PROGRAM** to change display to:

UP/DN TO CHANGE
CURRENT 55
3. Press  **SELECT** or  **RETURN** to set the required temperature.
4. Press  **ENTER** to confirm program changes and return to main menu.

P8. Setting the Night Temperature

The **Night Temperature** can be used in 2 ways:

1. To provide basic **frost protection** in conjunction with the **frost temperature** (P9).
2. To provide night time economies on 24 hour systems by selecting a lower **flow temperature** during the programmed **off** periods.

1. Press  or  to select program 8:

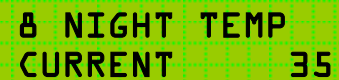

2. Press  to change display to:

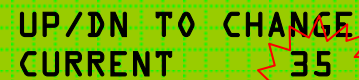

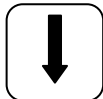
3. Press  or  to set the required temperature.

4. Press  to confirm program changes and return to main menu.
-

P9. Setting the Frost Temperature













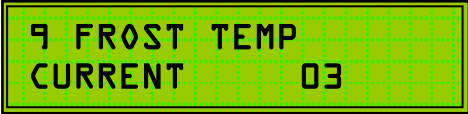

The **Frost Temperature** can be set to cancel the **Night Temperature** (P8) at a programmed external temperature.

E.G. For **frost protection** only set P9 to say 1°C.

The **night temperature** will not be activated until the external temperature falls to this level.



If the unit is installed in a nursing or residential home it may be possible to set P9 to 15°C - 16°C so that the **night temperature** will not be activated at temperatures above this and the heating will switch off.

If **night temperature** is required whatever the external temperature, set P9 to maximum, i.e. 35°C. Discuss this aspect with the building manager / owner to establish the requirements.



1. Press  or  to select program 9:
 or 

2. Press  to change display to:

3. Press  or  to set the required temperature.
 or 
4. Press  to confirm program changes and return to main menu.



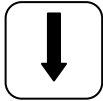

10. Setting the External Cut-Off Temperature

The **External Cut-Off Temperature** sets the outside temperature above which the heating system will switch off. This setting is also referred to as the Summer Cut-Off Temperature. The heating will come back on at 2°C below the External Cut-Off Temperature.

1. Press  **SELECT** or  **RETURN** to select program 10:

10 EXT C/O TEMP
CURRENT 35
2. Press  **PROGRAM** to change display to:

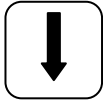











UP/DN TO CHANGE
CURRENT 35
3. Press  **SELECT** or  **RETURN** to set the required temperature.
4. Press  **ENTER** to change display to:

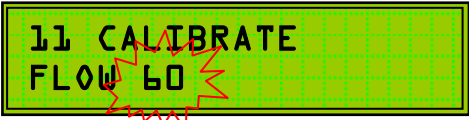

EXT C/O MODE
HTG ONLY
5. Press  **SELECT** or  **RETURN** to set HTG ONLY or HTG + HW.
6. Press  **ENTER** to confirm program changes and return to main menu.

Set to **HTG + HW** for boilers that provide hot water during the summer months. If the boiler is for heating only then set to **HTG ONLY**.

11. Calibration

Program 11 allows individual calibration of the Flow, Return and External temperature sensors. Each sensor reading can be adjusted by $-10^{\circ}\text{C}/+20^{\circ}\text{C}$.

1. Press  or  to select program 11:
SELECT RETURN 
2. Press and hold  for approx 10 secs to display:
PROGRAM 
3. Press  or  to adjust the displayed temp ($-10^{\circ}\text{C}/+20^{\circ}\text{C}$).
SELECT RETURN
4. Press  to confirm program changes and display:
ENTER 
5. Press  or  to adjust the displayed temp ($-10^{\circ}\text{C}/+20^{\circ}\text{C}$).
SELECT RETURN
6. Press  to confirm program changes and display:
ENTER 











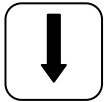



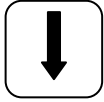

7. Press  or  to adjust the displayed temp (-10°C/+20°C).
SELECT **RETURN**
8. Press  to confirm program changes and return to main menu.
ENTER
-

12. HW Boost / HW 24 Hours

NOTE This program can only be changed when the EXT C/O MODE in P10 is set to HTG + HW.

Setting HW BOOST to YES will fire the boiler every Sunday at 02:00 AM for a period of 2 hours in order to assist in the control of legionella. The boiler will fire to its current thermostat setting.

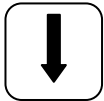
Setting HW 24 HOURS to YES will fire the boiler for hot water demand irrespective of the current programmed ON/OFF times set in P2.

1. Press  or  to select program 12:
 or 

2. Press  to change display to:

3. Press  or  to set as required.
 or 
4. Press  to change display to:

5. Press  or  to set as required.
 or 

Exiting Programming Mode

To exit from the programming mode, first ensure that the display indicates you are in the main menu.

At this point, press  to exit programming mode.
ENTER

The display will change to:



ENERGY MASTER
ACTIVE



And then, after a few seconds to:





FIRING Tu 15:35
S57 F50 R42 E05

The display may show slightly different information depending on the current mode of operation, i.e. firing, economising etc.

Note: When in programming mode the Energy Master will revert to normal running mode if the keypad is not operated for a period of 30 seconds (4 minutes if in program change mode).

To access programming mode from normal running mode:

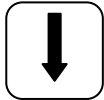
Press  and then select required program with  .
PROGRAM SELECT RETURN

Make any program changes as described previously.
