

Total Energy Controls



TEC 100/200 Programming & Installation Manual

As of software v7.2

Contents

Description	Page
Installation Instructions	
General Notes	3
Mains Wiring	3
Control Wiring	4
Other Wiring Options	5
Fitting and Wiring Temperature Sensors	6
Temperature Display Calibration	8
Commissioning Instructions	
Introduction	9
Keypad Overview	9
Establishing the System Max Flow Temp	11
Setting the Programs	12
Setting the Calendar	12
Programming the On / Off Times	14
Frequency (How the Time Clock works)	16
Select Days	17
Optimise On Time	18
Optimise Off Time	19
Setting the Maximum Flow Temperature	20
Setting the Minimum Flow Temperature	21
Setting the Minimum Return Temperature	22
Setting the Mid Temperature	23
Setting the Night Temperature	24
Setting the Frost Temperature	25
Setting the External Cut-Off Temperature	26
The Plant Relay	27
Hot Water Priority	28
Internal / External Optimisation	29
Calibration	30
Rotation	32
Exiting Programming Mode	33
TEC 100/200 with Monitoring Socket	
Monitor Installation and Operation	34

Installation

General Notes

The installation of all TEC units should be carried out by a qualified electrical engineer familiar with heating systems and control wiring.

All control circuits of TEC units are 'volt free' and may be used to switch 240V AC or low voltage control systems.

Extreme care must be taken to ensure that all wiring is correct before applying power, as irreparable damage to the PCB could result due to incorrect connections.

Mains Wiring

Unscrew the four screws of the TEC 100/200 and remove the lid to gain access to the PCB and wiring connections.

A 240V AC 1Ph 50Hz supply may be taken from the existing time clock switched or permanent supply, or direct from the boiler mains input connections (where available), whichever is the most suitable. The 240V connection to the TEC 100/200 is shown in Fig.1 below.

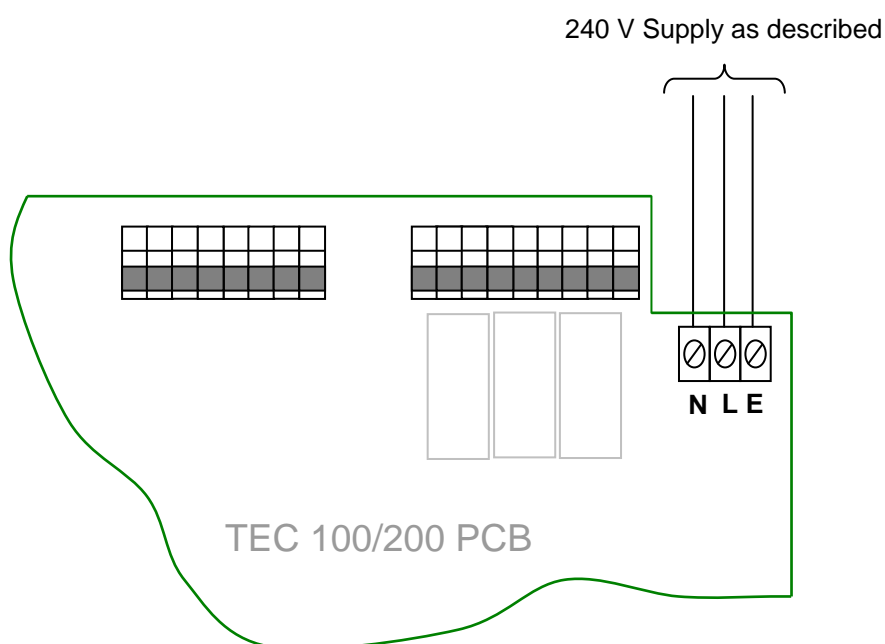

Fig. 1

Control Wiring

NOTE: If a wiring harness is provided in the rear of the enclosure please follow cables to TEC 100/200 PCB to determine connections as described in the following sections.

Many boilers are provided with an accessible mains terminal block. Most have a pair of connections (usually unused) for use with external controls. These connections will have a link which needs to be removed so that the TEC 100/200 control wires can be connected as shown in Fig.2.

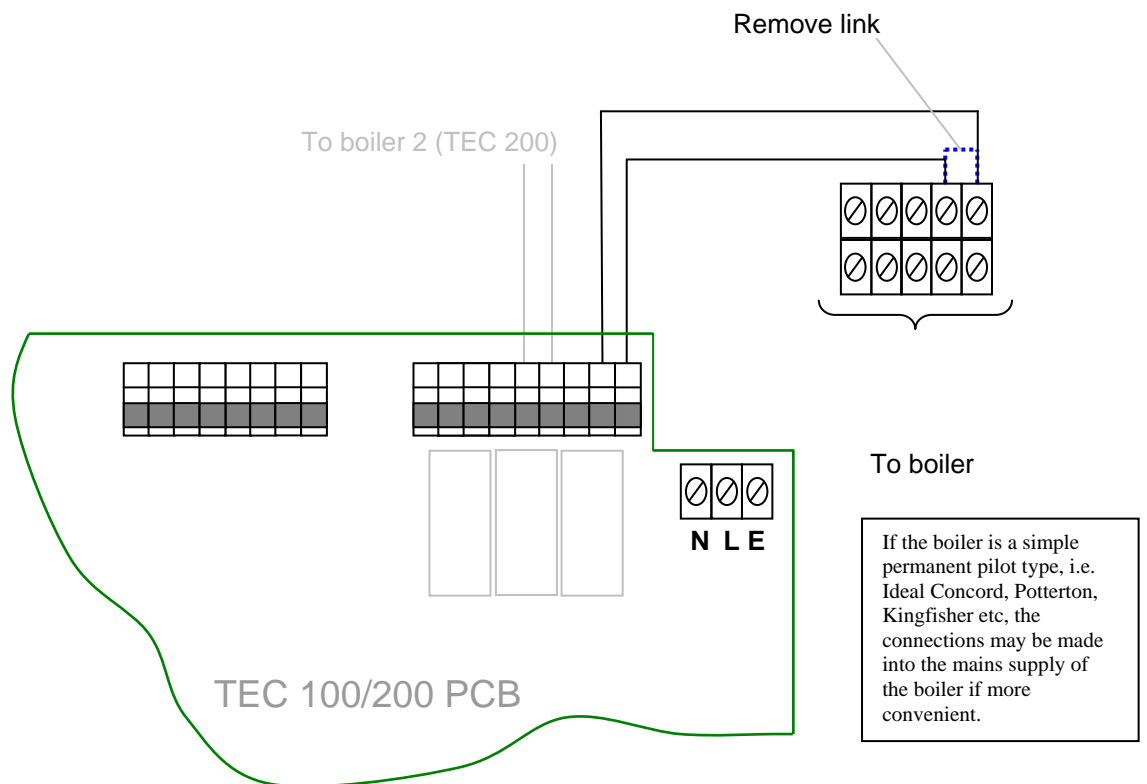

Fig. 2

Note: A 5-core heat resistant flex is ideal for connecting the TEC 100/200 to the boiler. The recommended connection method is via a flexible nylon conduit to house the cable.

Where a terminal block arrangement as shown in Fig.2 is not available, the control wiring should be connected directly into the boiler thermostat wiring as shown in Fig.3.

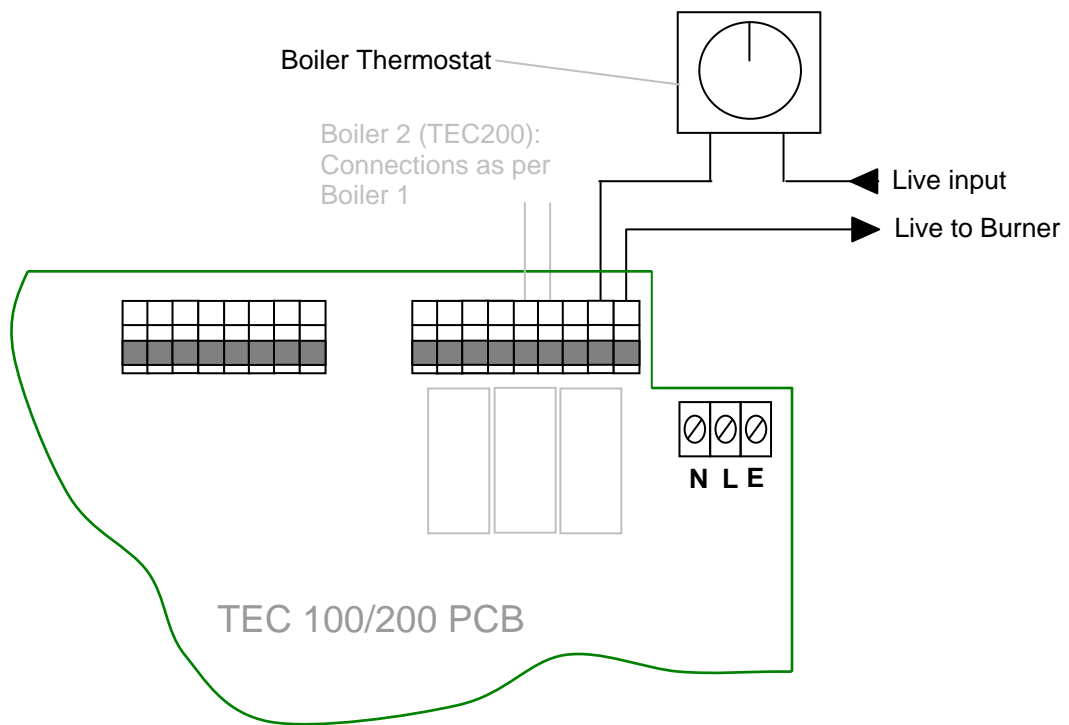

Fig. 3

Other Wiring Options

The TEC 100/200 has three control relays. On the TEC 100 the left hand relay is the **Plant Relay** which may be used to control a circulating pump and the right hand relay is the **boiler control circuit**. The centre relay (Tec 100 only) make and breaks on RTN/HW settings and may be used to control a HW pump, solenoid etc, see Fig 4. On the TEC 200 the left hand relay is the **Plant Relay**, the middle relay is **boiler 2 control circuit** and the right hand relay is **boiler 1 control circuit**.

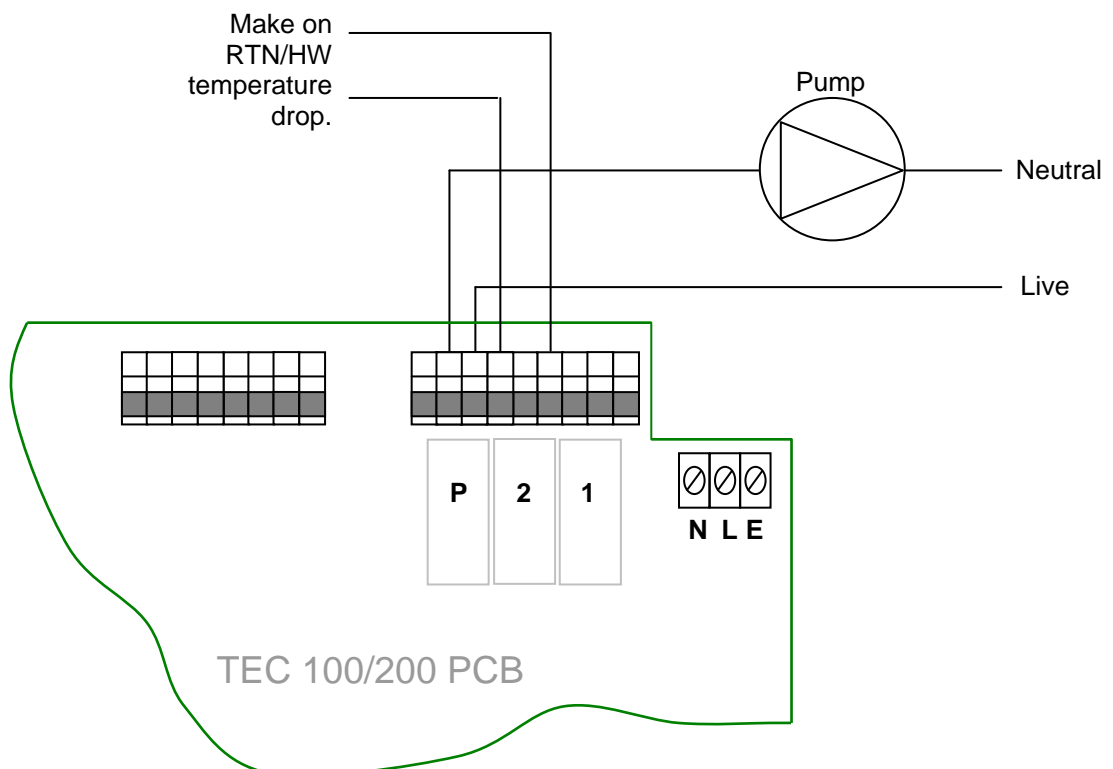

Fig. 4

Fitting and Wiring Temperature Sensors

The TEC 100/200 has three temperature sensor inputs, these being **Flow**, **Return/Hot Water** and **External**. Connections are as shown in Fig.5.

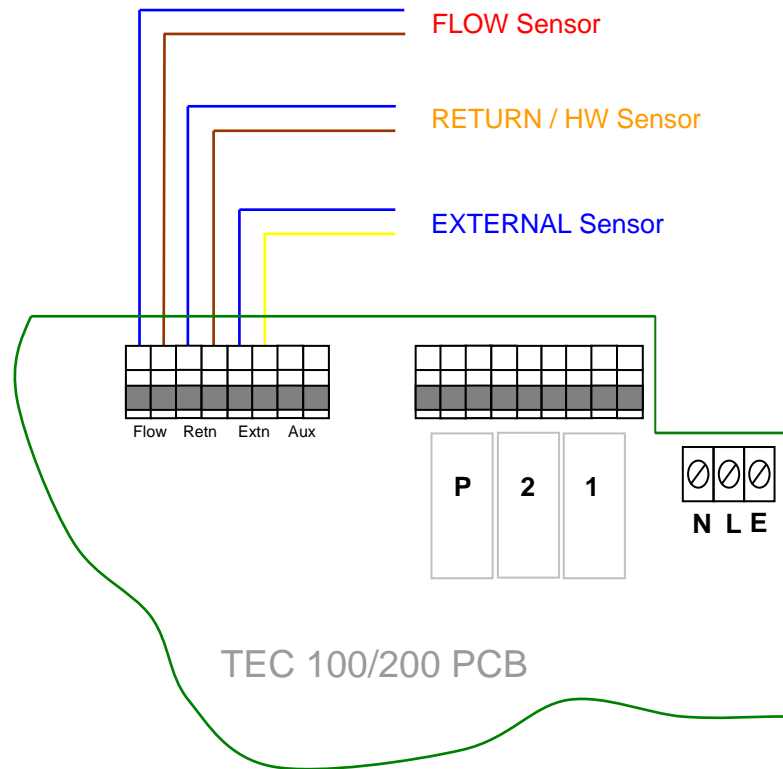

Fig. 5

Flow / Return Temperature Sensors (Cable Type)

Using **heat resistant** cloth tape, **tightly** strap the sensors to the relevant **flow** and **return** pipes, **close** to boiler, **before** any branching connections. Cover the sensors with heating pipe insulation and strap with ty-wraps or similar. See Fig.6.

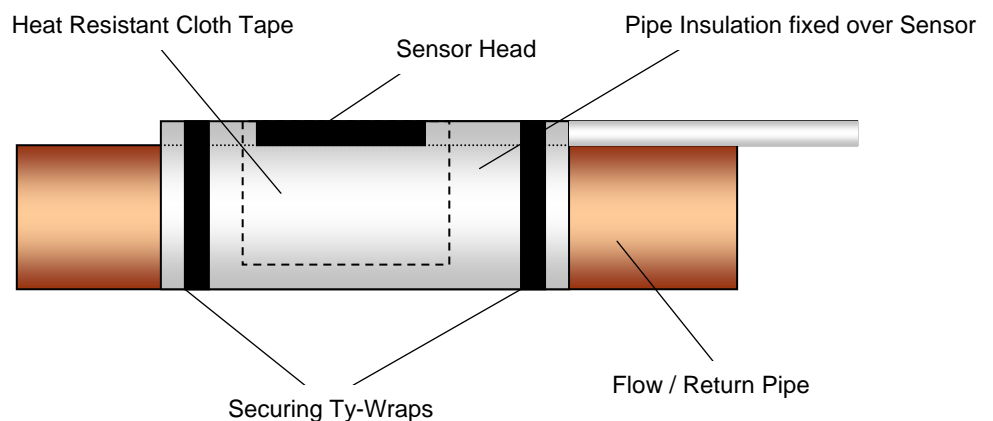

Fig. 6

Optional Hot Water Tank Sensor connections (replaces Return Temperature Sensor) are shown in Fig.7.

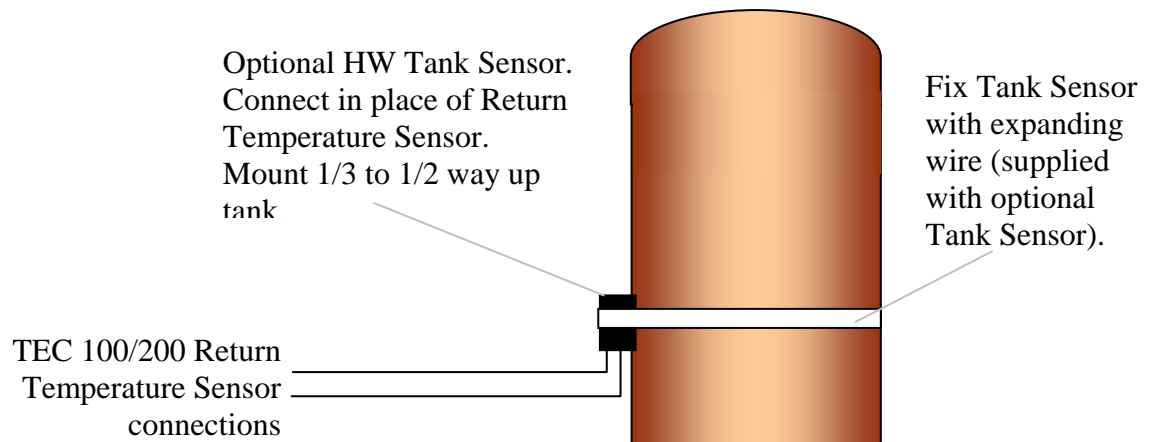

Fig. 7

If the hot water tank is a distance from the boiler, wiring to it may be impractical.

If hot water priority is important then the **Return Sensor** should be fitted to the **Hot Water Tank Return Pipe**. If this is also impractical, then fit as normal to the main **Return Pipe** and set the **Minimum Return Temperature** to provide an adequate level of hot water supply.

Where the tank option is used, set the **Minimum Return Temperature** to the stored water temperature requirement.

External Sensor

The **External Sensor** should preferably be positioned on a north facing exterior wall, and connected to the appropriate terminals of the TEC 100/200. If it is not possible to mount the sensor on a north facing wall, then mount in a shaded position, under eaves, and away from boiler house vent grilles etc.

Note A special reflective, insulated external sensor is available when fitting in a position where solar heat is unavoidable.

Temperature Display Calibration

When required, the temperatures as displayed on the TEC 100/200 may be adjusted to cater for heat losses on pipework, losses on external temperature sensor etc. Program 17 (see page 30) can be used to calibrate the temperature display by $-10^{\circ}\text{C}/+20^{\circ}\text{C}$.

Commissioning - Introduction

The TEC 100/200 Digital has 18 main programs, these being:

- | | | |
|-----|--------------------------------|----------------------------------|
| 1. | Calendar | |
| 2. | On/Off Times | (Two On/Off Periods per day) |
| 3. | Frequency | (Once, Twice, 24 Hours) |
| 4. | Select Days | (Every Day, Weekends, Week Days) |
| 5. | Optimise On Time | (0 to 240 minutes) |
| 6. | Optimise Off Time | (0 to 240 minutes) |
| 7. | Maximum Flow Temperature | (30°C to 85°C) |
| 8. | Minimum Flow Temperature | (25°C to 85°C) |
| 9. | Minimum Return Temperature | (20°C to 65°C) |
| 10. | Mid Temperature | (0°C to 85°C) |
| 11. | Night Temperature | (0°C to 85°C) |
| 12. | Frost Temperature | (0°C to 35°C) |
| 13. | External Cut Off Temperature | (0°C to 35°C) |
| 14. | Differential | (1°C to 5°C) |
| 15. | Hot Water Priority | (Yes / No) |
| 16. | Internal/External Optimisation | (Yes / No) |
| 17. | Calibration | (-10°C/+20°C) |
| 18. | Rotation | (Yes / No) |

Certain Differentials and the Compensation Slope are fixed within the software, i.e. Return Temp 2°C, External Temp 2°C, Compensation Slope 1.5.

Keypad and Running Mode Overview



PROGRAM

Used to enter Programming Mode from normal running mode, and to access Change Mode for the selected program.



SELECT

Used to cycle through the program list when in Programming Mode and to change program settings when in Change Mode.

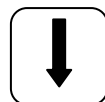

RETURN

Used to cycle through the program list when in Programming Mode and to change program settings when in Change Mode.



ENTER

Used to confirm a programming change and to exit from the Programming Mode.

The TEC 100/200 will go into **Boost** mode from a cold start. It will stay in this mode for 15 minutes, or until the **Return Temp** is within 10°C of the **Flow Temp**. If a **Hot Water Sensor** is fitted then the TEC 100/200 will go into **Boost** mode if the **HW Tank** is cold.

Firing mode indicates that the boiler is firing.

Temp Set indicates that the **actual Flow Temp** is above the **system set temperature****. The boiler will **not** be firing at this point.

Economising indicates that the TEC 100/200 has entered self learning mode and is making economies. The boiler will **not** be firing at this point.

Ext 'flashing' indicates that the external temp is above the level set in the **Ext Cut-Off** program.

** The **system set temperature** as indicated in the display, represents the heating system aiming temperature based on current climatic conditions, as determined by the TEC 100/200's weather compensation circuitry.

Establishing the System Maximum Flow Temp

Switch on the power to the TEC 100/200.

1. Set the **Bypass Switch** to the bypass position.
Allow the heating system to cycle twice at the normal winter setting of the boiler thermostat (see plant engineer, caretaker, maintenance manger etc to establish winter thermostat position).

2. The display will show:

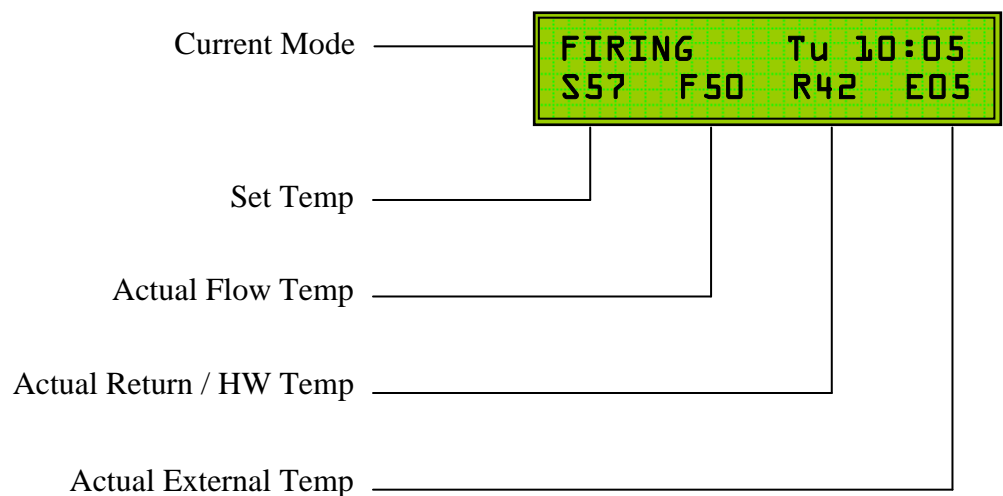

3. When the actual **Flow Temperature** exceeds the **Set Temperature**, the display will change:

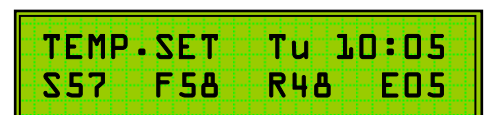

4. When the boiler has cycled twice with the TEC 100/200 in **bypass**, observe the **actual flow temperature** as shown on the display:

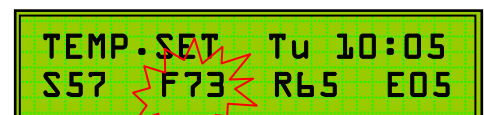











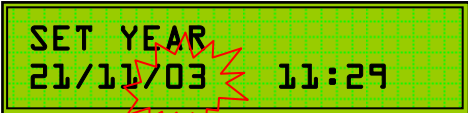

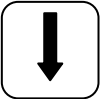

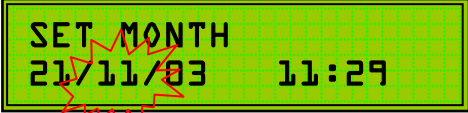

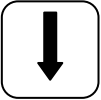

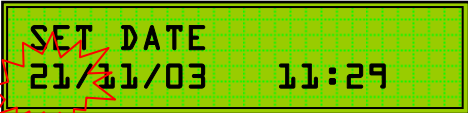

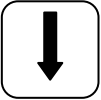



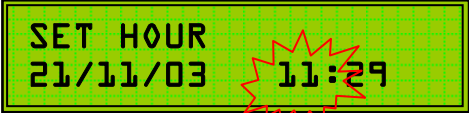

In this example, the winter setting for the heating system (TEC 100/200 maximum flow setting) should be set to 72°C (73°C - 1°C).

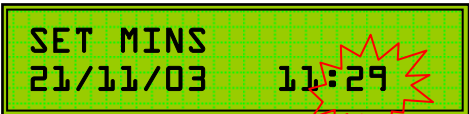
The Boiler Thermostat should now be set to a higher setting to ensure correct operation of the TEC 100/200.

Setting the Programs

P1. Setting the Calendar (Factory Set)

1. Press  to change display to: 
2. Press  again to display: 
3. Press  or  to set the year.
4. Press  to change display to: 
5. Press  or  to set the month.
6. Press  to change display to: 
7. Press  or  to set the date.

8. Press  to change display to: 
9. Press  or  to set the hour.
8. Press  to change display to: 
9. Press  or  to set the minutes.
10. Press  to change display to: 
11. Press  or  to set the day.
12. Press  to confirm the program change and return to main menu.
13. Press  to advance to next program.
-

P2. Programming the Time Clock (On/Off Times)

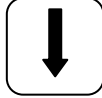
1. Press  or  to select program 2:

SELECT

RETURN



2. Press  again to display:

PROGRAM



There are two (2) programmable On/Off times per day.

The second OFF time must ALWAYS be programmed, and set to a time after, but in the same 24 hour period as the first ON time.

3. To change On/Off Times select the required day with

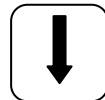

SELECT RETURN

4. Press  to enter programming mode for the chosen day:

PROGRAM



5. Press  to set first ON time:

PROGRAM



6. Press  or  to set the hour as required.

SELECT

RETURN

7. Press  to set first ON time minutes:

ENTER



8. Press  or  to set the minutes as required.

9. Press  to set first OFF** time:

MØ	1	07:30	-	00:00
*	2	00:00	-	18:30

** If the FIRST OFF time is not required leave at 00:00.

Adjust HOUR and MINUTES in the same way as previously described.

10. Press  to set the second ON time and repeat as above.

11. Press  to set the second OFF time and repeat as above.

If different On/Off times are required for each day, then repeat the above instructions for each day's times.

To repeat a days On/Off times into the next day, select the next day as

described above and press  followed by .

12. Press  to confirm program changes and return to main menu.

P3. Frequency (How the Time Clock operates)

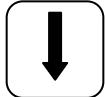
1. Press  or  to select program 3:
 SELECT RETURN

3 FREQUENCY
CURRENT ONCE

2. Press  to display:
 PROGRAM

UP/DN TO CHANGE
CURRENT ONCE

3. Press  or  to set as described below:
 SELECT RETURN

ONCE The time clock operates from the first ON time to the second OFF time.

TWICE The time clock operates on both ON and OFF times i.e. two On/Off periods per day.

24 HOUR The time clock operates 24 hours a day regardless of the On/Off settings.

4. Press  to confirm program changes and return to main menu.
 ENTER
-

P4. Select Days

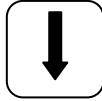
1. Press  or  to select program 4:
SELECT **RETURN**

4 SELECT DAYS
CURRENT EVERY DAY

2. Press  to display:
PROGRAM

UP/DN TO CHANGE
CURRENT ~~EVERY DAY~~

3. Press  or  to set as described below:
SELECT **RETURN**

EVERY DAY

The heating will operate everyday as set by the time clock On/Off times.

WEEK ENDS

The heating will operate at week ends only as set by time clock On/Off time for Sat – Sun. If reduced heating is required at week ends then set the time clock for reduced hours during Saturday and Sunday, and then set program 4 to EVERY DAY.

WEEK DAYS

The heating will operate during week days only as set by the time clock On/Off times Mon – Fri. The heating will be OFF at weekends.

4. Press  to confirm program changes and return to main menu.
ENTER
-

P5. Optimise On (Pre-Heat)

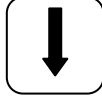
1. Press  or  to select program 5:
 SELECT RETURN

5 OPTIMISE ON
CURRENT 000 MINS

When programming a **Variable Pre-Heat** period (Optimum On) the first switch on time (P2) should be set to the buildings occupation time. If a **variable pre-heat** period is **not** required, then the first switch on time must allow for a sufficient warm-up period before occupation time.

When selected, the full programmed **variable pre-heat** period will occur at 0°C external temperature. At temperatures above 0°C the system will calculate the required **pre-heat** time.

Note: To assure adequate temperatures are achieved by occupation time the maximum **pre-heat** period must satisfy the building's thermal characteristics.

If Optimum On is not required then set to 000 mins.

2. Press  to display:
PROGRAM

UP/DN TO CHANGE
CURRENT 000 MINS

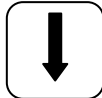
3. Press  or  to set the required number of minutes.
SELECT RETURN

4. Press  to confirm program changes and return to main menu.
ENTER

P6. Optimise Off

1.

Press  or  to select program 6:

SELECT

RETURN



↳ OPTIMISE OFF
CURRENT 000 MINS

Optimum Off periods will, when selected, switch off a boiler / heating system earlier than the programmed **off** time.

At 15°C external temperature the full **optimum off** period will occur and the boilers will switch off early. At 0°C external temperature there will be **no optimum off** and the boilers will switch off at the normal programmed time. At external temperatures between 0°C and 15°C the system will calculate the required **off** time.

If Optimum Off is not required then set to 000 mins.

2.

Press  to display:

PROGRAM



UP/DN TO CHANGE
CURRENT 000 MINS

3.

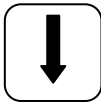
Press  or  to set the required number of minutes.

SELECT

RETURN

4.



Press  to confirm program changes and return to main menu.

ENTER

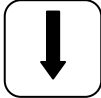

P7. Setting the Maximum Flow Temperature

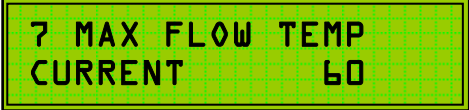
1. Press  or  to select program 7:

SELECT **RETURN**

 2. Press  to change display to:

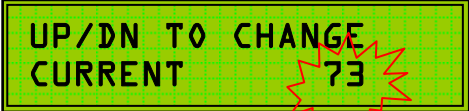

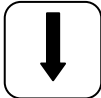







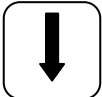

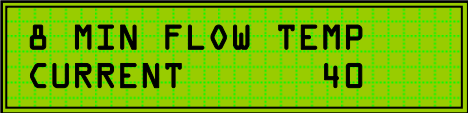
PROGRAM

 3. Press  or  to change the temperature setting to that required (i.e. 73°C).

SELECT **RETURN**
 4. Press  to confirm the program changes and return to main menu.

ENTER
-

P8. Setting the Minimum Flow Temperature

1. Press  or  to select program 8:
 or 

2. Press  to change display to:

3. Press  or  to change the temperature setting to that required.
 or 
4. Press  to confirm the program changes and return to main menu.

Setting a Minimum Flow Temperature is required to limit the effect of the Compensation. The flow temperature will not fall below that set in the Minimum Flow program (- differential), even if the compensated flow temperature is below this level.

The Minimum Flow Temperature should be chosen to meet heating criteria.

P9. Setting the Minimum Return Temperature

The **Minimum Return** temperature will depend on the type of heating system:

Heating and Hot Water.

Where convenient, the return temperature sensor should be fitted to the hot water storage tank (see installation instructions), the hot water return pipework or the hot water circulating pipework.



The **minimum return temperature** should be set to provide normal hot water tank temperature, i.e. 60°C.

Heating Only.

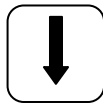
In this instance, the **minimum return temperature** should be set to the boiler manufacturers recommended level, i.e. 55°C for oil fired systems, 50°C or lower for gas fired systems. These figures are examples only. Refer to your boiler manual for manufacturer recommended settings.

1. Press  **SELECT** or  **RETURN** to select program 9:

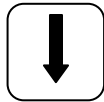







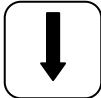

9 MIN RETN TEMP
CURRENT 50
2. Press  **PROGRAM** to change display to:

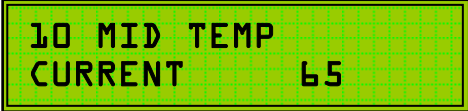
UP/DN TO CHANGE
CURRENT 55
3. Press  **SELECT** or  **RETURN** to set the required temperature.
4. Press  **ENTER** to confirm program changes and return to main menu.

P10. Setting the Mid Temperature

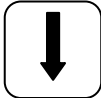
The **Mid Temperature** is used (if required) to set the **flow** temperature during the period between the **1st Off Time** and the **2nd On Time**.

If a second **On Period** is not required, then set **Frequency (P3)** to **Once**.

1. Press  or  to select program 10:
 or 

 2. Press  to change display to:

 3. Press  or  to set the required temperature.
 or 
 4. Press  to confirm program changes and return to main menu.

-

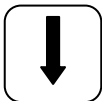
P11. Setting the Night Temperature

The **Night Temperature** can be used in 2 ways:

1. To provide basic **frost protection** in conjunction with the **frost temperature** (P12).
2. To provide night time economies on 24 hour systems by selecting a lower **flow temperature** during the programmed **off** periods.

1. Press  or  to select program 11:



2. Press  to change display to:

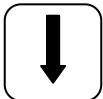

3. Press  or  to set the required temperature.

4. Press  to confirm program changes and return to main menu.

P12. Setting the Frost Temperature

The **Frost Temperature** can be set to cancel the **Night Temperature** (P11) at a programmed external temperature.

E.G. For **frost protection** only set P12 to say 1°C.

The **night temperature** will not be activated until the external temperature falls to this level.

If the unit is installed in a nursing or residential home it may be possible to set P12 to 15°C - 16°C so that the **night temperature** will not be activated at temperatures above this and the heating will switch off.

If **night temperature** is required whatever the external temperature, set P12 to maximum, i.e. 35°C. Discuss this aspect with the building manager / owner to establish the requirements.

Operation of the Frost Temperature will cancel 24 Hr Hot Water Priority.

1.

Press



or

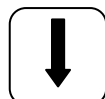

to select program 12:

12 FROST TEMP
CURRENT 03

2.

Press



to change display to:

UP/DN TO CHANGE
CURRENT 03

3.

Press



or

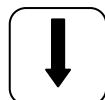

to set the required temperature.

4.



Press







to confirm program changes and return to main menu.

13. Setting the External Cut-Off Temperature

The **External Cut-Off Temperature** sets the outside temperature above which the heating system will switch off. This setting is also referred to as the Summer Cut-Off Temperature. The heating will come back on at 2°C below the External Cut-Off Temperature.

1. Press  **SELECT** or  **RETURN** to select program 13:

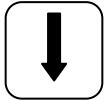
13 EXT C/O TEMP
 CURRENT 35
 2. Press  **PROGRAM** to change display to:

UP/DN TO CHANGE
 CURRENT 35
 3. Press  **SELECT** or  **RETURN** to set the required temperature.
 4. Press  **ENTER** to confirm program changes and return to main menu.
-

14. Differential

The **Differential** should be set to match existing boiler thermostat cycling temperature.

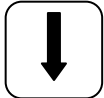
1. Press  or  to select program 14:
SELECT RETURN

14 DIFF
 CURRENT 2





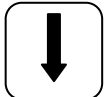





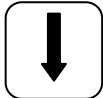

 2. Press  to change display to: PROGRAM

UP/DN TO CHANGE
 CURRENT 2

 3. Press  or  to set required differential.
SELECT RETURN

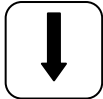
 4. Press  to confirm program changes and return to main menu.
ENTER
-

P15. Hot Water Priority (24 Hour)

1. Press  or  to select program 15:
 or 

2. Press  to change display to:

3. Press  or  to set YES, NO or HW Only.
 or 
4. Press  to confirm program changes and return to main menu.

When set to **NO** the TEC 100/200 Hot Water Priority operates during the programmed **ON** periods.

When set to **YES**, 24 hour hot water priority is provided.

When set to **HW ONLY** the **plant relay** controlling the heating pump will switch off when the **external cut-off** temperature is exceeded. This may only be set if a separate HW pump is installed, or gravity flow to the hot water cylinder is used.

Note: The centre relay of the **TEC 100** is programmed to operate at the **RTN/HW** temperature setting and may be used to control the HW pump etc.

Consideration should be given to the **Night Temperature** when setting Hot Water Priority. It should also be noted that operation of the **Frost Temperature** can cancel 24 Hour Hot Water Priority.



P16. Internal / External Optimisation



Program 16 allows the TEC 100/200 to utilise either Internal AND External Optimisation or just External Optimisation.



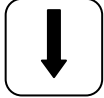



Internal Optimisation requires the heating pump to be connected to the Plant/Pump Relay as described on page 5.

To use both modes of Optimisation set to YES.

To use just External Optimisation set to NO.











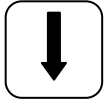







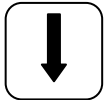

1. Press  or  to select program 16:
 



16 INT&EXT OPTIM
 CURRENT NO
 2. Press  to change display to:



UP/DN TO CHANGE
 CURRENT NO
 3. Press  or  to set YES or NO.
 
 4. Press  to confirm program changes and return to main menu.

-

P17. Calibration

Program 17 allows individual calibration of the Flow, Return and External temperature sensors. Each sensor reading can be adjusted by $-10^{\circ}\text{C}/+20^{\circ}\text{C}$.

1. Press  or  to select program 17:
 

2. Press  to change display to:

3. Press  or  to adjust the displayed temp ($-10^{\circ}\text{C}/+20^{\circ}\text{C}$).
 
4. Press  to confirm program changes and display:

5. Press  or  to adjust the displayed temp ($-10^{\circ}\text{C}/+20^{\circ}\text{C}$).
 
6. Press  to confirm program changes and display:



7. Press  or  to adjust the displayed temp (-10°C/+20°C).
SELECT **RETURN**

8. Press  to confirm program changes and return to main menu.
ENTER

P18. Rotation (TEC 200 only)

Program 18 allows the TEC 200 to rotate the lead boiler every 24 hours.

When set to YES the lead boiler is changed at midnight i.e. boiler 1 leads one day, and boiler 2 the next, then boiler 1 next etc etc.

When set to NO the boiler connected as boiler one will always be the lead boiler.

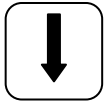
1. Press  or  to select program 18:
SELECT RETURN

18 ROTATION
 CURRENT YES

 2. Press  to change display to:
PROGRAM

UP/DN TO CHANGE
 CURRENT NO

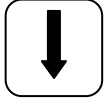
 3. Press  or  to set YES or NO.
SELECT RETURN

 4. Press  to confirm program changes and return to main menu.
ENTER
-

Exiting Programming Mode

To exit from the programming mode, first ensure that the display indicates you are in the main menu.

At this point, press  to exit programming mode.
ENTER

The display will change to:



TEC 100 V3
ACTIVE



And then, after a few seconds to:





FIRING Tu 15:35
S57 F50 R42 E05

The display may show slightly different information depending on the current mode of operation, i.e. boost, firing, economising etc.

Note: When in programming mode the TEC 100/200 will revert to normal running mode if the keypad is not operated for a period of 30 seconds (4 minutes if in program change mode).

To access programming mode from normal running mode:

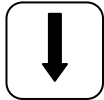
Press  and then select required program with  .
PROGRAM SELECT RETURN

Make any program changes as described previously.

TEC 100/200 with Monitor Socket

The TEC 100/200 is available with a pre-wired **Monitoring Socket**. In such a case, the control wiring must be as shown in Fig.3 (page 5).

The power supply to the unit **must** be from a **permanent** source to enable the monitoring system to function in the correct manner.

Within the TEC 100/200 you will see an **orange fly lead**. This should be connected to the **timeswitch output** to provide a signal for the **demand meters** (lower set).

If for any reason the system will not allow connections into the control thermostat as shown in Fig.3, then remove the **red link** wire as shown in Fig.9. Connect the **white fly lead** to the now spare connector on the **monitor socket** (originally connected to red link), and connect directly to burner supply to provide a signal for the **firing meters** (upper set).

The monitoring system has an integral digital timer that has been programmed to operate the **Day On/Day Off** changeover at 00:05 – 00:10 hrs. Open the monitor lid and operate the **change button** on the digital timer to initiate an **active period** (red LED off).

With the boiler firing and the heating timeswitch **on**, the two **active** meters should be operating. The **top** active meter indicating **firing hours**, and the **bottom** active meter indicating **demand** hours.

If they are not operating, re-check all connections.

Allow the TEC 100/200 to reach **Temp Set** mode (boiler cut-off), and note the **firing** meter has stopped. Operate the **change button** on the digital timer to initiate a **bypass period** (red LED on). Providing that the boiler thermostat is **on**, the boiler will re-fire (TEC 100/200 bypassed), and the **bypass** meters will operate. The **top** bypass meter indicating **firing hours**, and the **bottom** bypass meter indicating **demand** hours.

When ready to start the monitored test, operate the **change button** on the digital timer to enter an **active** period (red LED off), ensuring that the timer is itself in the **off** state. If necessary, reset the hour meters to zero with the **reset button** provided in the top right hand corner of the unit. The system will now

record **firing** and **demand** hours in both **active** and **bypass** modes. These modes will alternate on a day to day basis.

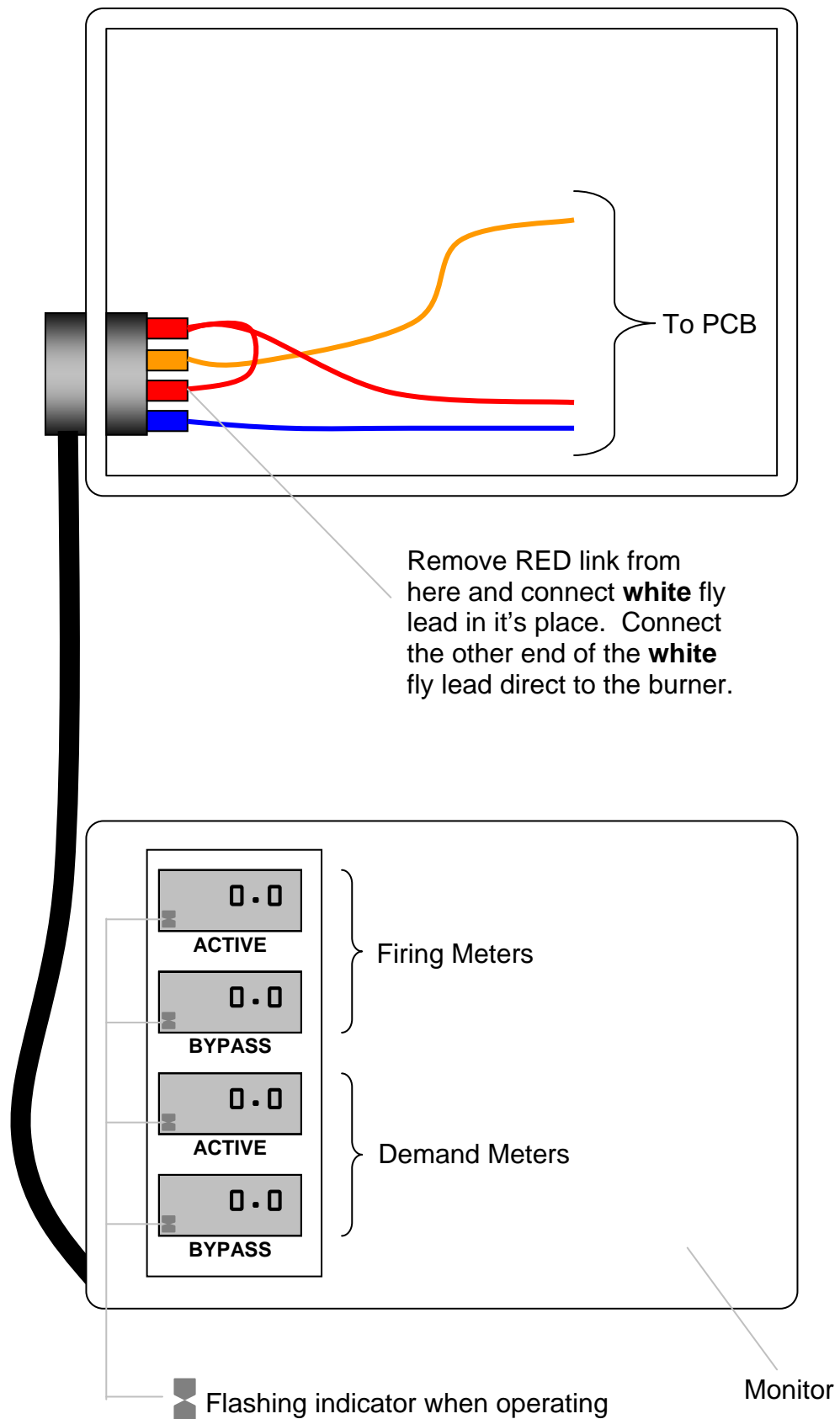

Fig. 9