

Total Energy Controls

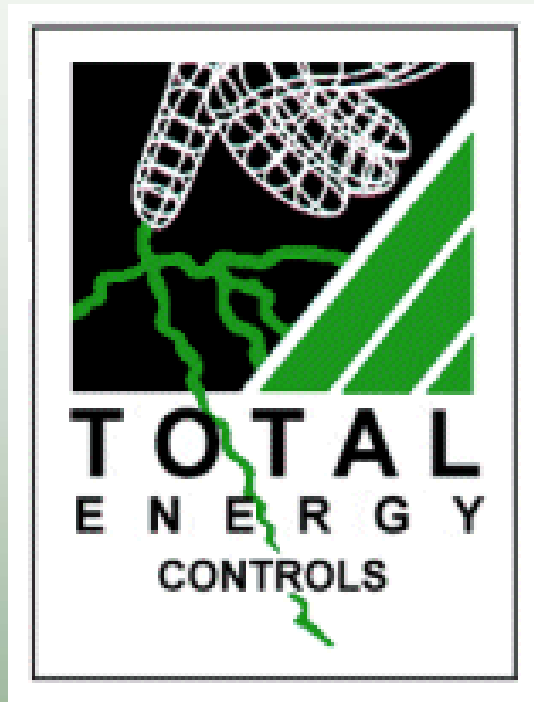

TEC 200 Programming & Installation Manual

PCB Version 6 and 8

Contents

Description	Page
Installation Instructions	
General Notes	3
Mains Wiring	3
Control Wiring	4
Other Wiring Options	5
Fitting and Wiring Temperature Sensors	6
Temperature Display Calibration	8
Commissioning Instructions	
Introduction	9
Keypad Overview	10
Establishing the System Max Flow Temp	11
Setting the Programs	12
Setting the Calendar	13
Programming the On / Off Times	16
Frequency (How the Time Clock operates)	18
Select Days	19
Optimise On Time (Pre-Heat)	20
Optimise Off Time	21
Setting the Maximum Flow Temperature	22
Setting the Minimum Flow Temperature	23
Setting the Minimum Return / HW Temperature	24
Setting the Mid Temperature	25
Setting the Night Temperature	26
Setting the Frost Temperature	27
Setting the External Cut-Off Temperature and Heating / Hot Water Mode	28
Weather Compensation	30
Differential	30
Setting the Number of Boilers	31
Setting the Number of Hot Water Boilers	32
Differential	33
Sequencing	34
Calibration	35
Internal / External Optimisation	37
Back Up Time	38
Auto BST	39
Use Test Mode	40
Hot Water Boost and Hot Water Priority	41
Exiting Programming Mode	43
Monitoring Facility	44

Installation

General Notes

The installation of all TEC units should be carried out by a qualified electrical engineer familiar with heating systems and control wiring.

All control circuits of TEC units are 'volt free' and may be used to switch 240V AC or low voltage control systems.

Extreme care must be taken to ensure that all wiring is correct before applying power, as irreparable damage to the PCB could result due to incorrect connections.

Mains Wiring

Unscrew the four screws of the TEC 200 and remove the lid to gain access to the PCB and wiring connections.

A 240V AC 1Ph 50Hz supply may be taken from the existing time clock switched or permanent supply, or direct from the boiler mains input connections (where available), whichever is the most suitable. The 240V connection to the TEC 200 is shown in Fig.1 below.

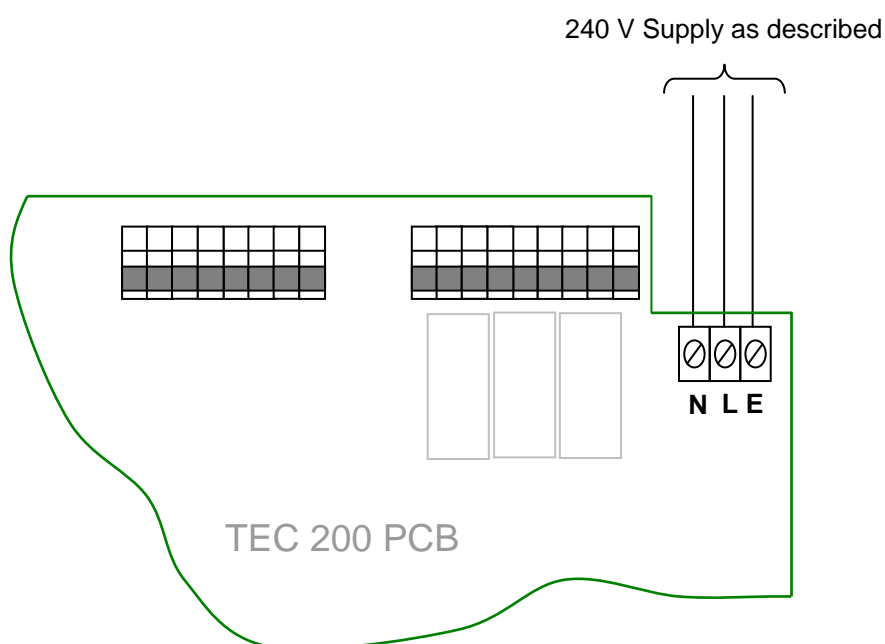

Fig. 1

Control Wiring

NOTE: If a wiring harness is provided in the rear of the enclosure please follow cables to TEC 200 PCB to determine connections as described in the following sections.

Many boilers are provided with an accessible mains terminal block. Most have a pair of connections (usually unused) for use with external controls. These connections will have a link which needs to be removed so that the TEC 200 control wires can be connected as shown in Fig.2.

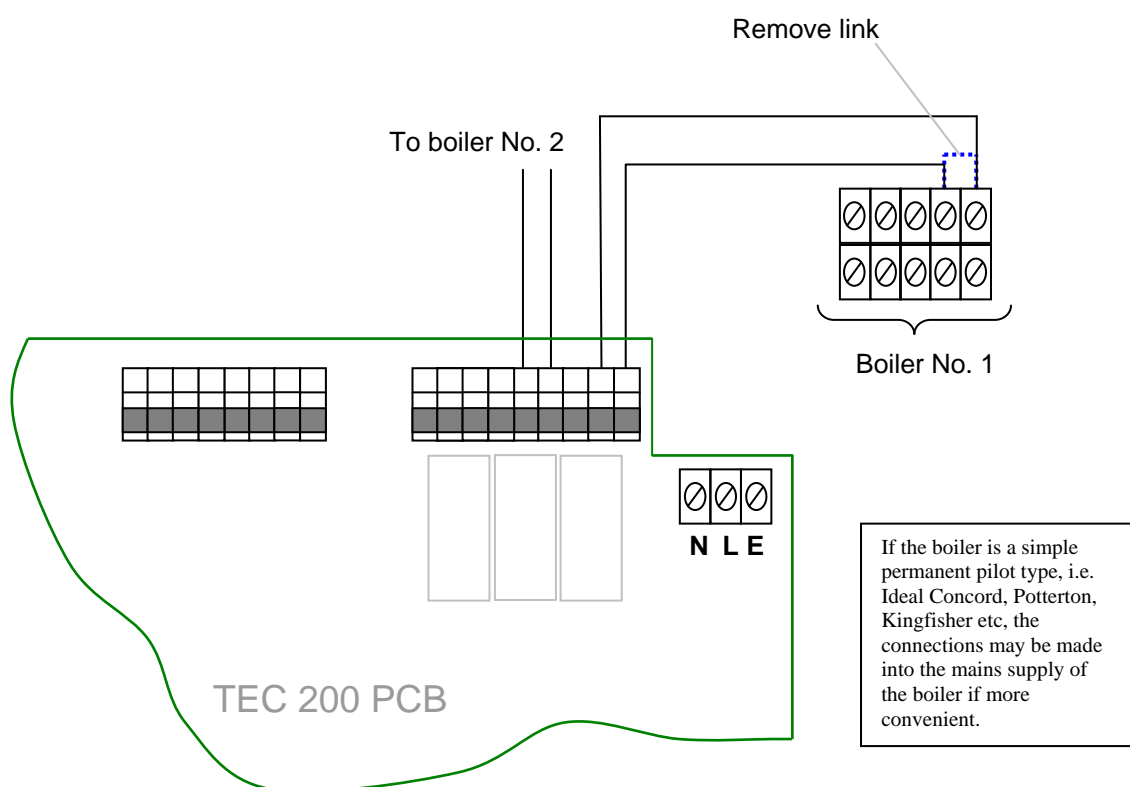

Fig. 2

Note: A 5-core heat resistant flex is ideal for connecting the TEC 200 to the boiler. The recommended connection method is via a flexible nylon conduit to house the cable.

Where a terminal block arrangement as shown in Fig.2 is not available, the control wiring should be connected directly into the boiler thermostat wiring as shown in Fig.3.

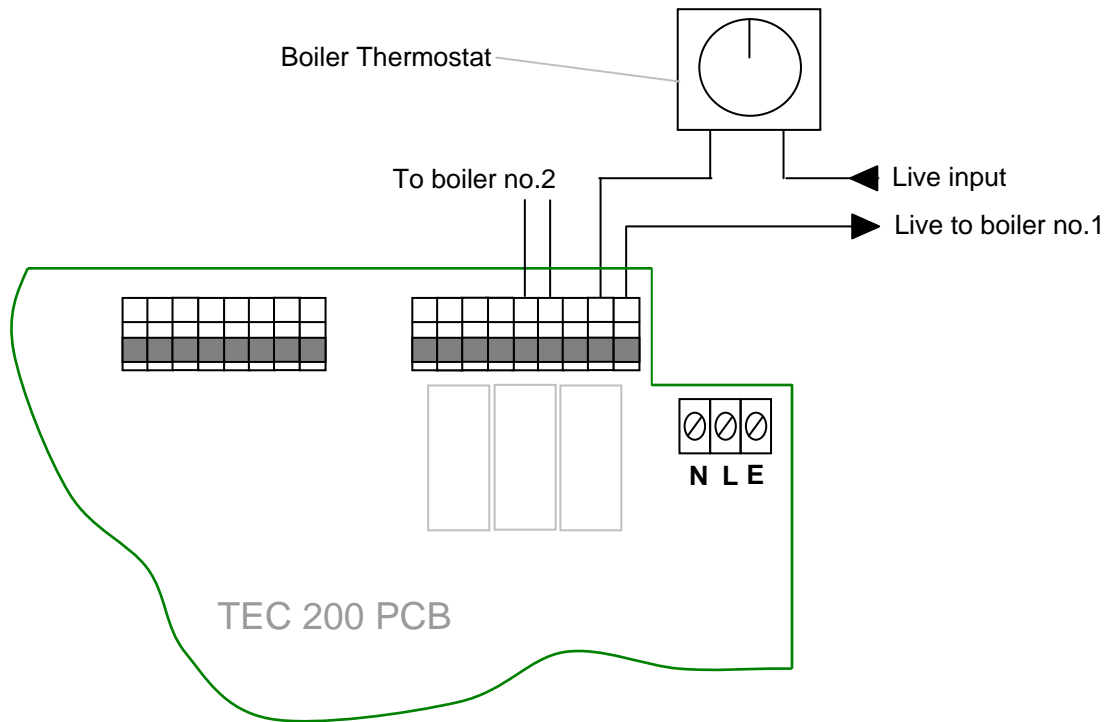

Fig. 3

Other Wiring Options

The TEC 200 has three control relays. The left hand relay is the **plant relay** which may be used to control a circulating pump. The remaining relays are the **boiler control circuits**.

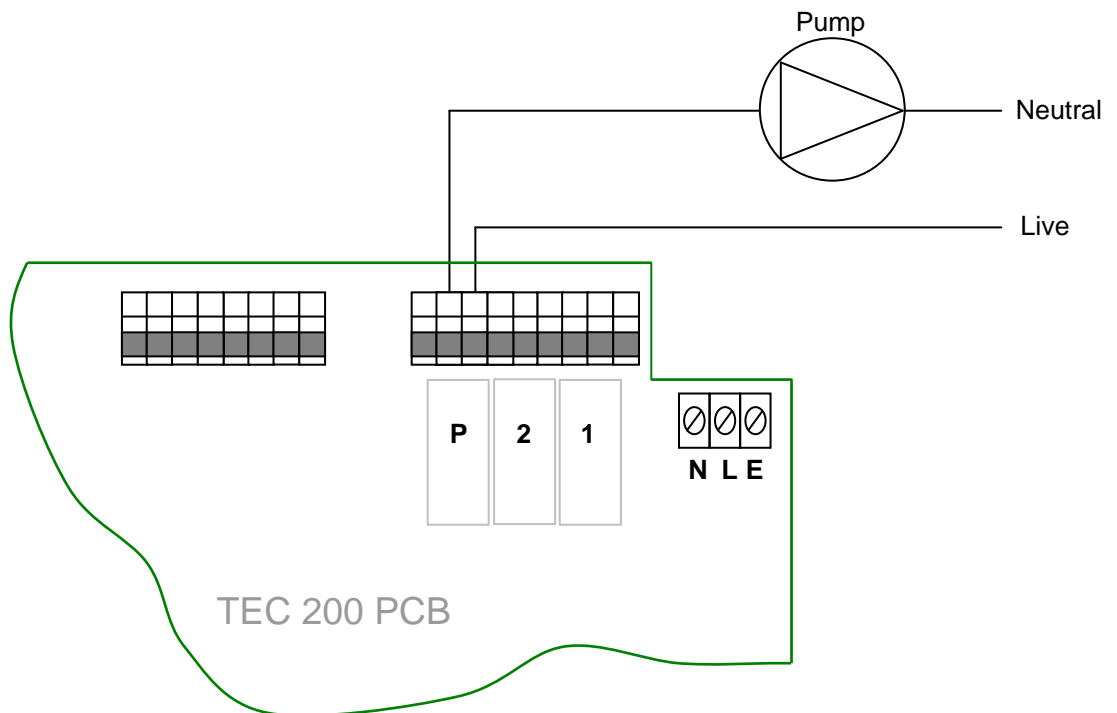

Fig. 4

Fitting and Wiring Temperature Sensors

The TEC 200 has three temperature sensor inputs, these being **Flow**, **Return/Hot Water** and **External**. Connections are as shown in Fig.5.

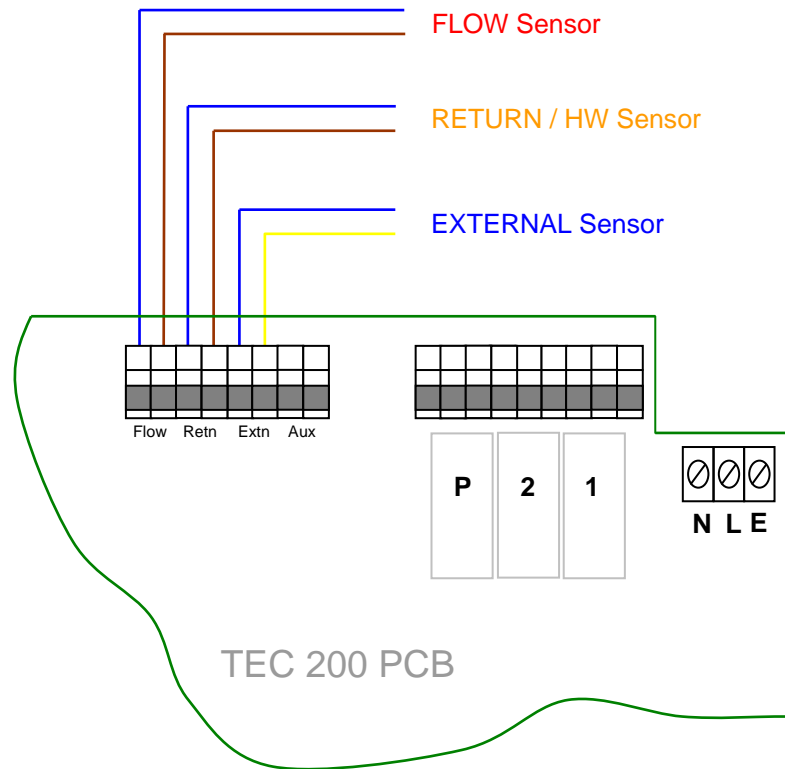

Fig. 5

Flow / Return Temperature Sensors (Cable Type)

Using **heat resistant** cloth tape, **tightly** strap the sensors to the relevant **flow** and **return** pipes, **close** to boiler, **before** any branching connections. Cover the sensors with heating pipe insulation and strap with ty-wraps or similar. See Fig.6.

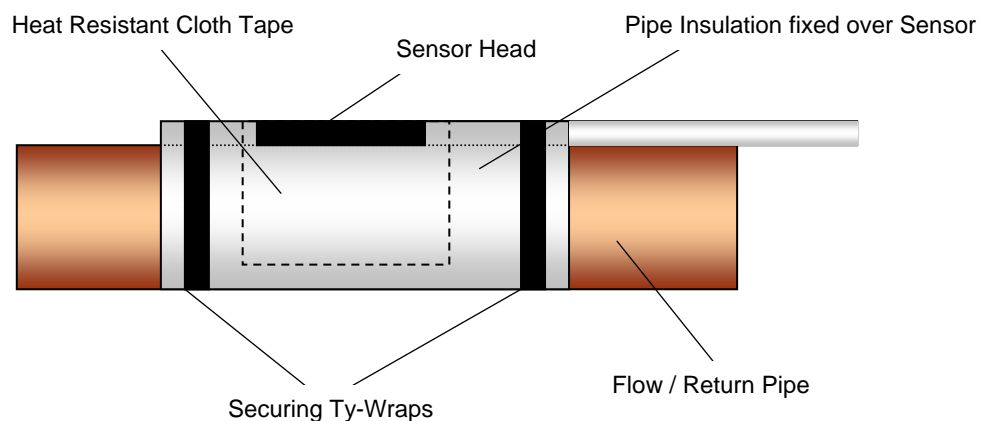

Fig. 6

Optional Hot Water Tank Sensor connections (replaces Return Temperature Sensor) are shown in Fig.7.

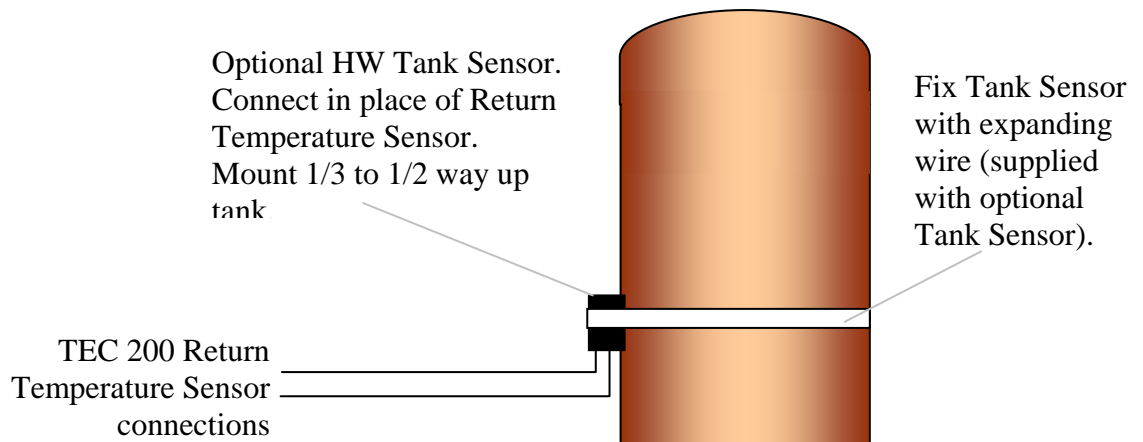

Fig. 7

If the hot water tank is a distance from the boiler, wiring to it may be impractical.

If hot water priority is important then the **Return Sensor** should be fitted to the **Hot Water Tank Return Pipe**. If this is also impractical, then fit as normal to the main **Return Pipe** and set the **Minimum Return Temperature** to provide an adequate level of hot water supply.

Where the tank option is used, set the **Minimum Return Temperature** to the stored water temperature requirement.

External Sensor

The **External Sensor** should preferably be positioned on a north facing exterior wall, and connected to the appropriate terminals of the TEC 200. If it is not possible to mount the sensor on a north facing wall, then mount in a shaded position, under eaves, and away from boiler house vent grilles etc.

Note A special reflective, insulated external sensor is available when fitting in a position where solar heat is unavoidable.

Temperature Display Calibration

When required, the temperatures as displayed on the TEC 200 may be adjusted to cater for heat losses on pipe work, losses on external temperature sensor etc. Program 19 (see page 30) can be used to calibrate the temperature display by $-10^{\circ}\text{C}/+20^{\circ}\text{C}$.

Commissioning - Introduction

The TEC 200 has 24 main programs, these being:

- | | | |
|-----|--------------------------------|----------------------------------|
| 1. | Calendar | |
| 2. | Set Occupancy (On/Off Times) | (Two On/Off Periods per day) |
| 3. | Frequency | (Once, Twice, 24 Hours) |
| 4. | Select Days | (Every Day, Weekends, Week Days) |
| 5. | Pre-Heat Time (Optimise On) | (0 to 240 minutes) |
| 6. | Optimise Off Time | (0 to 240 minutes) |
| 7. | Maximum HTG/HW Temperature | (30°C to 85°C) |
| 8. | Minimum HTG Temperature | (25°C to 85°C) |
| 9. | Return / Hot Water Temperature | (20°C to 65°C) |
| 10. | Mid Temperature | (0°C to 85°C) |
| 11. | Night Temperature | (0°C to 85°C) |
| 12. | Frost Temperature | (0°C to 35°C) |
| 13. | External Cut Off Temperature | (0°C to 35°C) |
| 14. | Compensation | (0°C to 3°C) |
| 15. | Number of Boilers | (1 or 2) |
| 16. | Hot Water Boilers | (0, 1 or 2) |
| 17. | Differential | (1°C to 5°C) |
| 18. | Sequence | (Yes / No) |
| 19. | Calibrate | (-10°C/+20°C) |
| 20. | Int & Ext Optimisation | (Yes / No) |
| 21. | Back Up Time | (0 to 30 minutes) |
| 22. | Auto BST | (Yes / No) |
| 23. | Use Test Mode | (Yes / No) |
| 24. | HW Boost & HW Priority | (Yes / No) |

Keypad and Running Mode Overview



PROGRAM

Used to enter Programming Mode from normal running mode, and to access Change Mode for the selected program.



SELECT

Used to cycle through the program list when in Programming Mode and to change program settings when in Change Mode.

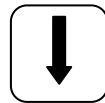

RETURN

Used to cycle through the program list when in Programming Mode and to change program settings when in Change Mode.



ENTER

Used to confirm a programming change and to exit from the Programming Mode.

Firing mode indicates that the boiler is firing. In Hi/Lo mode, 1 indicates the Lo Burner and 2 indicates the Hi Burner.

```

Fire1 P Mo15:17
S57 F50 R42 E12D
  
```

TmpSet indicates that the **actual Flow Temp** is above the **system set temperature****. The boiler will **not** be firing at this point.

```

TmpSet P Mo15:17
S57 F59 R53 E12D
  
```

Econ indicate that the TEC 200 has entered self learning mode and is making economies. The boiler may **not** be firing at this point.

```

Econ12 P Mo15:17
S57 F59 R53 E12D
  
```

E 'flashing' indicates that the external temp is above the level set in the **Ext Cut-Off** program or that set in the **Mid** or **Night Frost** temperatures.

```

TmpSet P Mo15:17
S57 F36 R34 E12D
  
```

D, M and **N** indicates whether the unit is in Day, Mid or Night mode.

```

TmpSet P Mo15:17
S57 F36 R34 E12D
  
```

** The **system set temperature** as indicated in the display, represents the heating system aiming temperature based on current climatic conditions, as determined by the TEC 200's weather compensation program.

Establishing the System Maximum Flow Temp

Switch on the power to the TEC 200.

1. Set the **Bypass Switch** to the bypass position.
Allow the heating system to cycle twice at the normal winter setting of the boiler thermostat (see plant engineer, caretaker, maintenance manger etc to establish winter thermostat position).

2. The display will show:

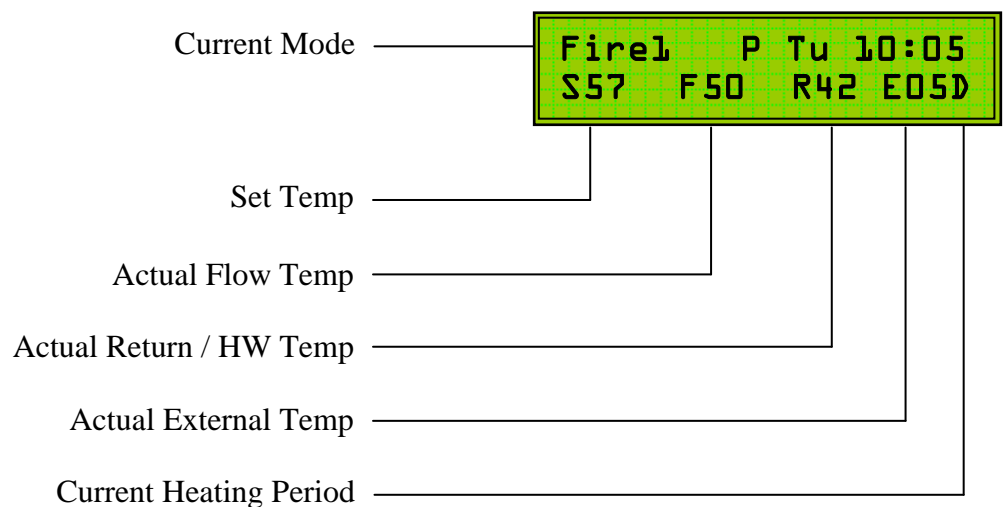

3. When the actual **Flow Temperature** exceeds the **Set Temperature**, the display will change:

TmpSet P Tu 10:05
S57 F58 R48 E05D

4. When the boiler has cycled twice with the TEC 100 in **bypass**, observe the **actual flow temperature** as shown on the display:





TmpSet P Tu 10:05
S57 F73 R65 E05D

In this example, the winter setting for the heating system (TEC 200 maximum flow setting) should be set to 72°C (73°C - 1°C).



The Boiler Thermostat should now be set to a higher setting to ensure correct operation of the TEC 200.

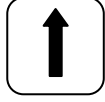
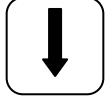

Setting the Programs





To enter the programming mode, please follow the steps below:



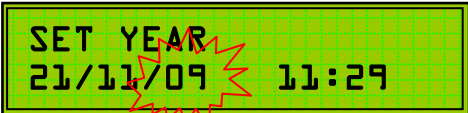

1. Hold  to change display to: 
PROGRAM
2. Press  to change display to: 
ENTER
3. Press  or  to select the required program.
SELECT **RETURN**
4. Adjust program settings as described in the following sections.

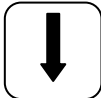

P1. Setting the Calendar (Factory Set)

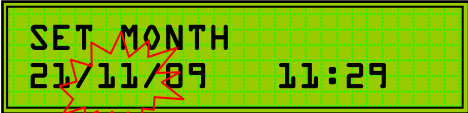
1. Press  or  to select program 1:
SELECT **RETURN**

2. Press  again to display:
PROGRAM

3. Press  or  to set the year.
SELECT **RETURN**
4. Press  to change display to:
ENTER

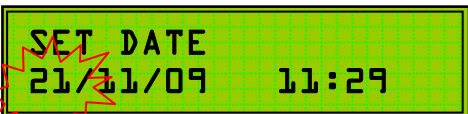
5. Press  or  to set the month.
SELECT **RETURN**
6. Press  to change display to:
ENTER

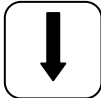

7. Press  or  to set the date.
SELECT **RETURN**

8.

Press

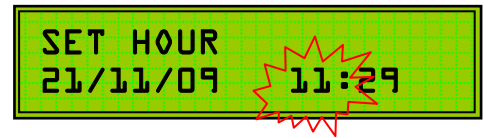

to change display to:



9.

Press



or



to set the hour.

8.

Press



to change display to:

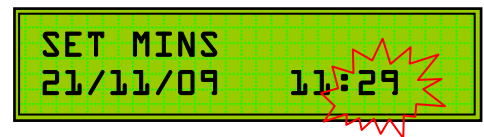

9.

Press



or



to set the minutes.

10.

Press



to change display to:



11.

Press



or



to set the day.

12.

Press



to change display to:

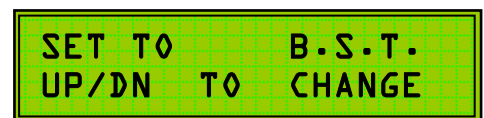

13.

Press



or



to select BST or GMT.

12. Press  to confirm the program change and return to main menu.
ENTER

13. Press  to advance to next program.
SELECT

P2. Programming the Time Clock (On/Off Times)

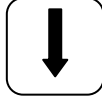
1. Press  or  to select program 2:

SELECT

RETURN



2. Press  again to display:

PROGRAM



There are two (2) programmable On/Off times per day.

The second OFF time must ALWAYS be programmed, and set to a time after, but in the same 24 hour period as the first ON time.

3. To change On/Off Times select the required day with

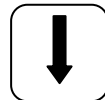

SELECT RETURN

4. Press  to enter programming mode for the chosen day:

PROGRAM



5. Press  to set first ON time:

PROGRAM



6. Press  or  to set the hour as required.

SELECT

RETURN

7. Press  to set first ON time minutes:

ENTER



8. Press  or  to set the minutes as required.

9. Press  to set first OFF** time:

M0	1	07:30-	12:00
*	2	13:00-	18:30

** If the FIRST OFF time is not required leave at 00:00.

Adjust HOUR and MINUTES in the same way as previously described.

10. Press  to set the second ON time and repeat as above.

11. Press  to set the second OFF time and repeat as above.

If different On/Off times are required for each day, then repeat the above instructions for each day's times.

To repeat a days On/Off times into the next day, select the next day as

described above and press  followed by .

12. Press  to confirm program changes and return to main menu.

P3. Frequency (How the Time Clock operates)

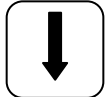
1. Press  or  to select program 3:
SELECT **RETURN**

3 FREQUENCY
CURRENT ONCE

2. Press  to display:
PROGRAM

UP/DN TO CHANGE
CURRENT ONCE

3. Press  or  to set as described below:
SELECT **RETURN**

ONCE The time clock operates from the first ON time to the second OFF time.

TWICE The time clock operates on both ON and OFF times i.e. two On/Off periods per day.

24 HOUR The time clock operates 24 hours a day regardless of the On/Off settings.

4. Press  to confirm program changes and return to main menu.
ENTER
-

P4. Select Days

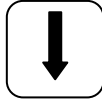
1. Press  or  to select program 4:
SELECT **RETURN**

4 SELECT DAYS
CURRENT EVERY DAY

2. Press  to display:
PROGRAM

UP/DN TO CHANGE
CURRENT EVERY DAY

3. Press  or  to set as described below:
SELECT **RETURN**

EVERY DAY

The heating will operate everyday as set by the time clock On/Off times.

WEEK ENDS

The heating will operate at week ends only as set by time clock On/Off time for Sat – Sun. If reduced heating is required at week ends then set the time clock for reduced hours during Saturday and Sunday, and then set program 4 to EVERY DAY.

WEEK DAYS

The heating will operate during week days only as set by the time clock On/Off times Mon – Fri. The heating will be OFF at weekends.

4. Press  to confirm program changes and return to main menu.
ENTER
-

P5. Optimise On (Pre-Heat)

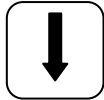
1. Press  or  to select program 5:
 SELECT RETURN

5 PRE-HEAT TIME
CURRENT 000 MINS

When programming a **Variable Pre-Heat** period (Optimum On) the first switch on time (P2) should be set to the buildings occupation time. If a **variable pre-heat** period is **not** required, then the first switch on time must allow for a sufficient warm-up period before occupation time.

When selected, the full programmed **variable pre-heat** period will occur at 0°C external temperature. At temperatures above 0°C the system will calculate the required **pre-heat** time.

Note: To assure adequate temperatures are achieved by occupation time the maximum **pre-heat** period must satisfy the building's thermal characteristics.

If Optimum On is not required then set to 000 mins.

2. Press  to display:
PROGRAM

UP/DN TO CHANGE
CURRENT 000 MINS

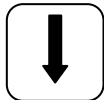
3. Press  or  to set the required number of minutes.
SELECT RETURN

4. Press  to confirm program changes and return to main menu.
ENTER

P6. Optimise Off

1.

Press



SELECT

or

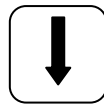

RETURN

to select program 6:

↳ OPTIMISE OFF
CURRENT 000 MINS

Optimum Off periods will, when selected, switch off a boiler / heating system earlier than the programmed **off** time.

At 15°C external temperature the full **optimum off** period will occur and the boilers will switch off early. At 0°C external temperature there will be **no optimum off** and the boilers will switch off at the normal programmed time. At external temperatures between 0°C and 15°C the system will calculate the required **off** time.

If Optimum Off is not required then set to 000 mins.

2.

Press



PROGRAM

to display:

UP/DN TO CHANGE
CURRENT 000 MINS

3.

Press



SELECT

or

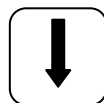

RETURN

to set the required number of minutes.

4.







Press



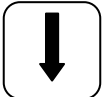
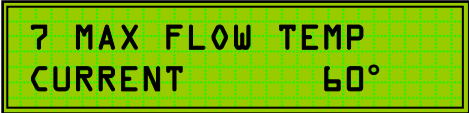









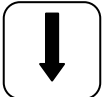

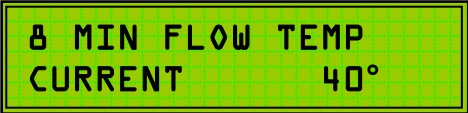
ENTER

to confirm program changes and return to main menu.

P7. Setting the Maximum Flow Temperature

1. Press  or  to select program 7:
SELECT **RETURN**

 2. Press  to change display to:
PROGRAM

 3. Press  or  to change the temperature setting to that required (i.e. 73°C).
SELECT **RETURN**
 4. Press  to confirm the program changes and return to main menu.
ENTER
-

P8. Setting the Minimum Flow Temperature

1. Press  or  to select program 8:
 or 

2. Press  to change display to:

3. Press  or  to change the temperature setting to that required.
 or 
4. Press  to confirm the program changes and return to main menu.

Setting a Minimum Flow Temperature is required to limit the effect of the Compensation. The flow temperature will not fall below that set in the Minimum Flow program (- differential), even if the compensated flow temperature is below this level.

The Minimum Flow Temperature should be chosen to meet heating criteria.

P9. Setting the Minimum Return / HW Temperature

The **Minimum Return / HW** temperature will depend on the type of heating system:

Heating and Hot Water.

Where convenient, the return temperature sensor should be fitted to the hot water storage tank (see installation instructions), the hot water return pipework or the hot water circulating pipework.



The **minimum return / HW temperature** should be set to provide normal hot water tank temperature, i.e. 60°C.

Heating Only.

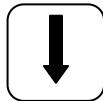
In this instance, the **minimum return temperature / HW** should be set to the boiler manufacturers recommended level, i.e. 55°C for oil fired systems, 50°C or lower for gas fired systems. These figures are examples only. Refer to your boiler manual for manufacturer recommended settings.

1. Press  **SELECT** or  **RETURN** to select program 9:

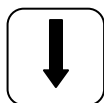
9 RTN/HW TEMP
CURRENT 50°
2. Press  **PROGRAM** to change display to:

UP/DN TO CHANGE
CURRENT 55°
3. Press  **SELECT** or  **RETURN** to set the required temperature.
4. Press  **ENTER** to confirm program changes and return to main menu.

P10. Setting the Mid Temperature

The **Mid Temperature** is used (if required) to set the **flow** temperature during the period between the **1st Off Time** and the **2nd On Time**.

If a second **On Period** is not required, then set **Frequency (P3)** to **Once**.

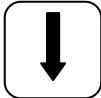
1. Press  or  to select program 10:

10 MID TEMP
CURRENT 65°

 2. Press  to change display to:

UP/DN TO CHANGE
CURRENT 65°

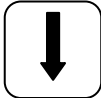
 3. Press  or  to set the required temperature.

 4. Press  to confirm program changes and return to main menu.
-

P11. Setting the Night Temperature

The **Night Temperature** can be used in 2 ways:

1. To provide basic **frost protection** in conjunction with the **frost temperature** (P12).
2. To provide night time economies on 24 hour systems by selecting a lower **flow temperature** during the programmed **off** periods.

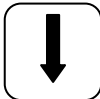
1. Press  or  to select program 11:



2. Press  to change display to:



3. Press  or  to set the required temperature.

4. Press  to confirm program changes and return to main menu.

P12. Setting the Frost Temperature

The **Frost Temperature** can be set to cancel the **Night Temperature** (P11) at a programmed external temperature.



E.G. For **frost protection** only set P12 to say 1°C.

The **night temperature** will not be activated until the external temperature falls to this level.



If the unit is installed in a nursing or residential home it may be possible to set P12 to 15°C - 16°C so that the **night temperature** will not be activated at temperatures above this and the heating will switch off.

If **night temperature** is required whatever the external temperature, set P12 to maximum, i.e. 35°C. Discuss this aspect with the building manager / owner to establish the requirements.

Operation of the Frost Temperature will cancel 24 Hr Hot Water Priority.

1. Press  **SELECT** or  **RETURN** to select program 12:

12 FROST TEMP
CURRENT 03°
2. Press  **PROGRAM** to change display to:

UP/DN TO CHANGE
CURRENT 03°
3. Press  **SELECT** or  **RETURN** to set the required temperature.
4. Press  **ENTER** to confirm program changes and return to main menu.



P13. Setting the External Cut-Off Temperature

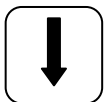

The **External Cut-Off Temperature** sets the outside temperature above which the heating system will switch off. This setting is also referred to as the Summer Cut-Off Temperature. The heating will come back on at 2°C below the External Cut-Off Temperature. If no cut-off is required then set to 35 °C.

The second stage of this program **EXT C/O MODE** is used to specify whether the system is used to provide heating only or both heating and hot water.

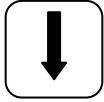
1. Press  **SELECT** or  **RETURN** to select program 13:

13 EXT C/O TEMP
 CURRENT 35°
2. Press  **PROGRAM** to change display to:

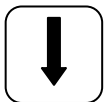
UP/DN TO CHANGE
 CURRENT 35°
3. Press  **SELECT** or  **RETURN** to set the required temperature.
4. Press  **ENTER** to change display to:

EXT C/O MODE
 HTG ONLY
5. Press  **SELECT** or  **RETURN** to set the required mode.
6. Press  **ENTER** to confirm program changes and return to main menu.

The two options for the second stage of P13 are:

HTG ONLY

When selected the boiler will fire for heating requirements only based on the programmed **ON** periods. **HW 24 HRS** should be set to **NO**. Both the boiler and the plant relay will switch off when the external temperature rises above the **External Cut-Off Temperature** (P13).

HTG + HW

When selected the boiler will fire for both heating and hot water requirements. Hot water demand is dictated by the optional hot water cylinder sensor which replaces the return temperature sensor (see page 7).



In this mode the **plant relay** controlling the heating pump will switch off when the **external cut-off** temperature is exceeded. This may only be set if a separate HW pump is installed, or gravity flow to the hot water cylinder is used.

P14. Weather Compensation



The **Compensation** setting controls the change in flow temperature relative to the change in the external temperature (weather compensation).

A setting of 1 will cause a fall in flow temperature of 1°C for every 1°C rise in external temperature above 0 °C.

The minimum that the flow temperature can fall is limited by P8 (Minimum Flow Temperature).

1. Press  **SELECT** or  **RETURN** to select program 14:

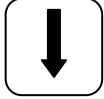
14 COMPENSATION
 CURRENT 0.5°
 2. Press  **PROGRAM** to change display to:

UP/DN TO CHANGE
 CURRENT 0.5°
 3. Press  **SELECT** or  **RETURN** to set the desired level.
 4. Press  **ENTER** to confirm program changes and return to main menu.
-

P15. Setting the Number of Boilers

Program 15 is used to set the number of boilers on the heating system.

1.

Press



or

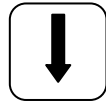

to select program 15:

15 NO OF BOILERS
CURRENT 2

2.

Press



to change display to:

UP/DN TO CHANGE
CURRENT 2

3.

Press



or

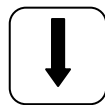

to set the number of boilers.

4.

Press



to confirm program changes and return to main menu.

P16. Setting the Number of Hot Water Boilers

Program 16 is used to set the number of boilers required for hot water

1.

Press



SELECT

or

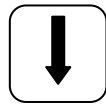

RETURN

to select program 16:

16 HW BOILERS
CURRENT 1

2.

Press



PROGRAM

to change display to:

UP/DN TO CHANGE
CURRENT 1

3.

Press



SELECT

or

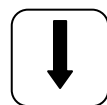

RETURN

to set the number of hot water boilers.

4.

Press









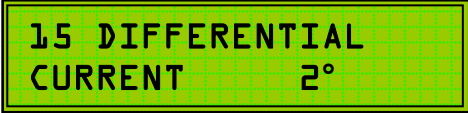

ENTER

to confirm program changes and return to main menu.



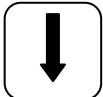









P17. Differential

The **Differential** should be set to match existing boiler thermostat cycling temperature.

1. Press  or  to select program 17:
SELECT **RETURN**

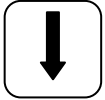
 2. Press  to change display to:
PROGRAM

 3. Press  or  to set required differential.
SELECT **RETURN**
 4. Press  to confirm program changes and return to main menu.
ENTER
-























P18. Sequence

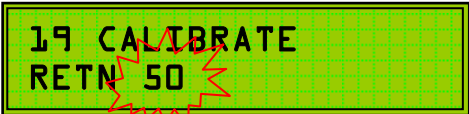

The **Sequence** program, when set to YES, changes the lead boiler every 24 hours.

1. Press  or  to select program 18:
 

 2. Press  to change display to:

 3. Press  or  to set YES or NO.
 
 4. Press  to confirm program changes and return to main menu.

-

P19. Calibrate

Program 19 allows individual calibration of the Flow, Return and External temperature sensors. Each sensor reading can be adjusted by $-10^{\circ}\text{C}/+20^{\circ}\text{C}$.

1. Press  or  to select program 19:
 or 

2. Press & hold  for approx 10 secs to change display to:

3. Press  or  to adjust the displayed temp ($-10^{\circ}\text{C}/+20^{\circ}\text{C}$).
 or 
4. Press  to confirm program changes and display:

5. Press  or  to adjust the displayed temp ($-10^{\circ}\text{C}/+20^{\circ}\text{C}$).
 or 
6. Press  to confirm program changes and display:



7. Press  or  to adjust the displayed temp (-10°C/+20°C).
SELECT **RETURN**

8. Press  to confirm program changes and return to main menu.
ENTER

P20. Internal / External Optimisation











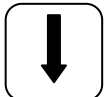

Program 20 allows the TEC 200 to utilise either Internal AND External Optimisation or just External Optimisation.

Internal Optimisation requires the heating pump to be connected to the Plant/Pump Relay as described on page 5.

To use both modes of Optimisation set to **YES**.

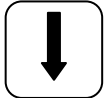
To use just External Optimisation set to **NO**.

Set to **NO** if the second stage of program 13 is set to **HEAT & HW**.

1. Press  or  to select program 20:
 or 

 2. Press  to change display to:

 3. Press  or  to set YES or NO.
 or 
 4. Press  to confirm program changes and return to main menu.

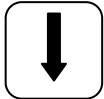
-

P21. Back Up Time

When installed onto a two boiler system , if the lead burner is unable to reach the required temperature but the flow temperature does not fall by the **Differential** setting (P17) to bring in the second boiler, then the second burner will be called after the time period set in **P21**.

1. Press  or  to select program 21:
SELECT RETURN

21 BACK UP TIME
 CURRENT 10

 2. Press  to change display to: PROGRAM



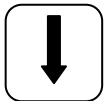





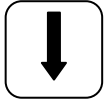

UP/DN TO CHANGE
 CURRENT 12

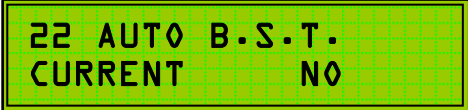
 3. Press  or  to set desired time.
SELECT RETURN

 4. Press  to confirm program changes and return to main menu.
ENTER
-

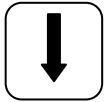











P22. Auto BST

Program 22 is used to provide automatic adjustment for GMT-BST seasonal time changes. Set to **Yes** to enable.

1. Press  or  to select program 22:
 or 

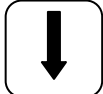
 2. Press  to change display to:

 3. Press  or  to set YES or NO.
 or 
 4. Press  to confirm program changes and return to main menu.

-

P23. Use Test Mode

Program 23 enables or disables the ability to use the TEC 200's inbuilt monitoring program. It does not start the test, it just allows the test mode to be used as described later.

1. Press  or  to select program 23:
 or 

 2. Press  to change display to:

 3. Press  or  to set YES or NO.
 or 
 4. Press  to confirm program changes and return to main menu.

-

P24. Hot Water Boost and Hot Water Priority

When set to **YES** the **Hot Water Boost** option will fire the boiler in order to heat the hot water for 2 hours every Sunday morning at 2AM. During this period the boiler will fire to it's own thermostat setting.

The second stage of this program sets the 24 hour **Hot Water Priority** option to either YES or NO:

HW 24 HRS YES

When set to **YES** 24 hour hot water priority is provided.

HW 24 HRS NO

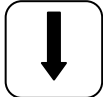

When set to **NO** the TEC 200 hot water priority operates during the programmed **ON** periods if **HEAT + HW** is selected.

1. Press  or  to select program 24:
SELECT RETURN

24 HW BOOST
CURRENT NO

2. Press  to change display to:
PROGRAM



UP/DN TO CHANGE
CURRENT NO

3. Press  or  to set as required.
SELECT RETURN

4. Press  to change display to:
ENTER

HW 24 HOURS
CURRENT NO

UP/DN TO CHANGE
CURRENT NO

5. Press  or  to set as required.
SELECT **RETURN**

6. Press  to confirm program changes and return to main menu.
ENTER

Consideration should be given to the **Night Temperature** when setting **Hot Water Priority**. It should be noted that operation of the **Frost Temperature** can cancel 24 Hour Hot Water Priority.

Exiting Programming Mode

To exit from the programming mode, first ensure that the display indicates you are in the main menu.

At this point, press  to exit programming mode.

The display will change to:



TEC 200
ACTIVE



And then, after a few seconds to:



FIRE12 P Tu 15:35
S57 F50 R42 E05D

The display may show slightly different information depending on the current mode of operation, i.e. boost, firing, economising etc.

Note: When in programming mode the TEC 200 will revert to normal running mode if the keypad is not operated for a period of 30 seconds (4 minutes if in program change mode).

Monitoring Facility (monitoring relay module required)

The TEC system has an option for monitoring energy savings using the day on/day off test procedure when supplied with the monitoring relay module.

The module should be connected to the main V6 or V8 PCB as shown:

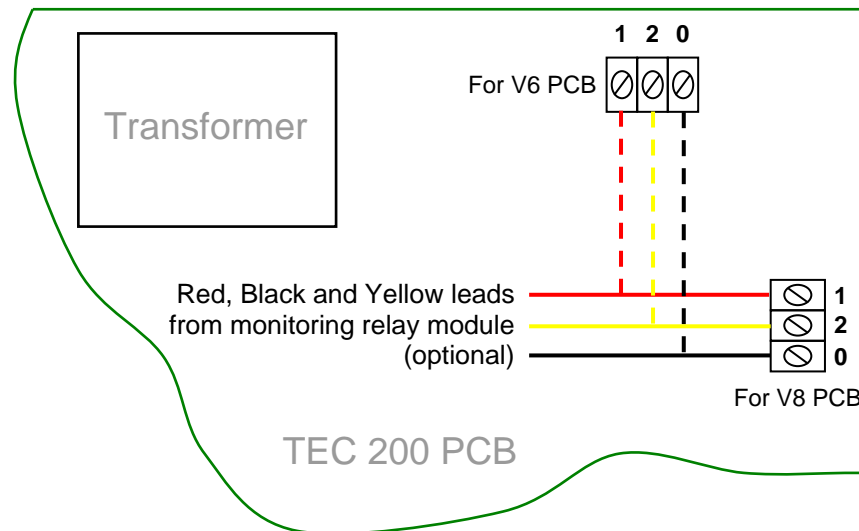

To use this facility Program 23 (Use Test Mode) should be set to **YES**.

The monitoring relay module is prewired to 2 x 3-way connector blocks as shown below (one for each burner/boiler):

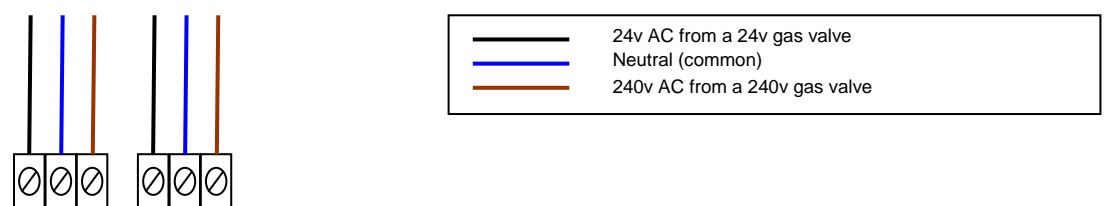

Connect gas valve supply (24v or 240v) to the 3-way connector as shown above. **DO NOT** connect a 240v gas valve supply to the 24v connection as permanent damage to the relay module will occur. As a precaution the 24v connection is plugged to prevent accidental connection of a 240v supply.

To enable the monitoring to function correctly, the 'Maximum Flow Temperature' must be set to coincide with normal boiler thermostat temperature setting. This is achieved by establishing the maximum flow temperature as described in the manual. The On/Off times in the TEC system should be set to match those of the existing time clock / programmer.

Starting the Monitored Test

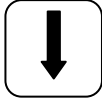
1. To start the monitored test press and hold the  button until all zeros appear on the display.

RETURN

Press the  button whilst the display is still showing zeros to start the test.

ENTER

2. To view current readings press and hold the  button until the active and bypass figures appear on the display.

SELECT

Press the  to resume the monitored test.

ENTER

3. To end the monitored test press and hold  whilst the display is still showing the active and bypass figures.

PROGRAM

‘Clear Log’ will appear on the display. Keep holding the  button and after several seconds the Energy Master will reset and revert to normal operation, i.e. not on test.

PROGRAM

4. To restart a test go to step 1.

Monitoring will commence at midnight whereby the unit will assume the ‘Bypass Mode’. The following midnight the TEC system will revert to ‘Active Mode’ whereby all energy saving techniques will be utilised as programmed.

This will be repeated throughout the test period (30 days), alternating between ‘Bypass’ and ‘Active’ every other day. When the test is over the unit will resume the normal, active running mode.
