



TEC VTR

**Installation, Commissioning
and User Manual**

Contents

Description	Page
Installation	3
General notes	3
Positioning and fixing the unit	3
Control wiring	3
Wiring to single or Hi/Lo boilers	4
Connections when no control links are available	4
Wiring to a twin/dual boiler system	7
Installing the sensors	8
Commissioning	10
Keypad overview	10
Display overview	11
Establishing the heating system maximum flow temperature	11
Program Menu	
Calendar	12
On/Off Times	15
Timer Mode	18
Select Days	19
Maximum Flow Temperature	20
Minimum Flow Temperature	21
Set Load Ratio	22
Set Rotation	23
Auto B.S.T.	24
Set External Level	25
Using the Active/Bypass Switch	26

Installation

General Notes

The TEC VTR unit must be installed by a qualified electrician in accordance with the current UK legislation, guidance or codes of practice. In the UK these are the 17th Edition Wiring Regulations BS7671-2008 and subsequent amendments.

It is also highly recommended that the installer has a good knowledge of boilers, heating systems and their control methods.

Please read these instructions and study the diagrams carefully before installation. Incorrect wiring may cause permanent damage to the unit rendering the warranty void.

Once the packaging has been removed and prior to installation, carry out a visual check to make sure there are no obvious signs of damage.

Ensure all electrical supplies to the property are fully isolated prior to any work taking place.

Positioning and fixing the unit

The unit is supplied with a pre-wired mains harness and flow and return temperature sensors.

Mount the controller using the keyhole slots on the rear of the unit and secure in position ensuring that the sensors and mains harness will reach their relevant positions.

Where the unit is used to control two boilers on a common header then the 7-core mains harness should be terminated in a junction box to allow convenient connections to each boiler and the mains supply.

Do not allow the cables to come into direct contact with the hot area of the heat exchanger or flue components.

Control Wiring

The TEC VTR system will control:

- a) A single boiler.
- b) A single Hi/Lo Boiler
- c) Two boilers on a common header.

The 7-core mains harness is rated at 6 amps and is colour coded as follows:

Brown	- 240V AC Live
Blue	- Neutral
Green/Yellow	- Earth
Red	} - Volt free switched pair for boiler 1
Black	
White	} - Volt free switched pair for Hi/Lo boiler or boiler 2
Grey	

Wiring to Single or Hi/Lo Boilers

Most commercial boilers will have a 'control link' in the wiring panel for the connection of external controls such as time clocks, room thermostats etc. This should be identified in the boiler installation manual and connected to as per Fig 1.

Fig 1. Typical Hi/Lo Boiler Terminal Block Connections

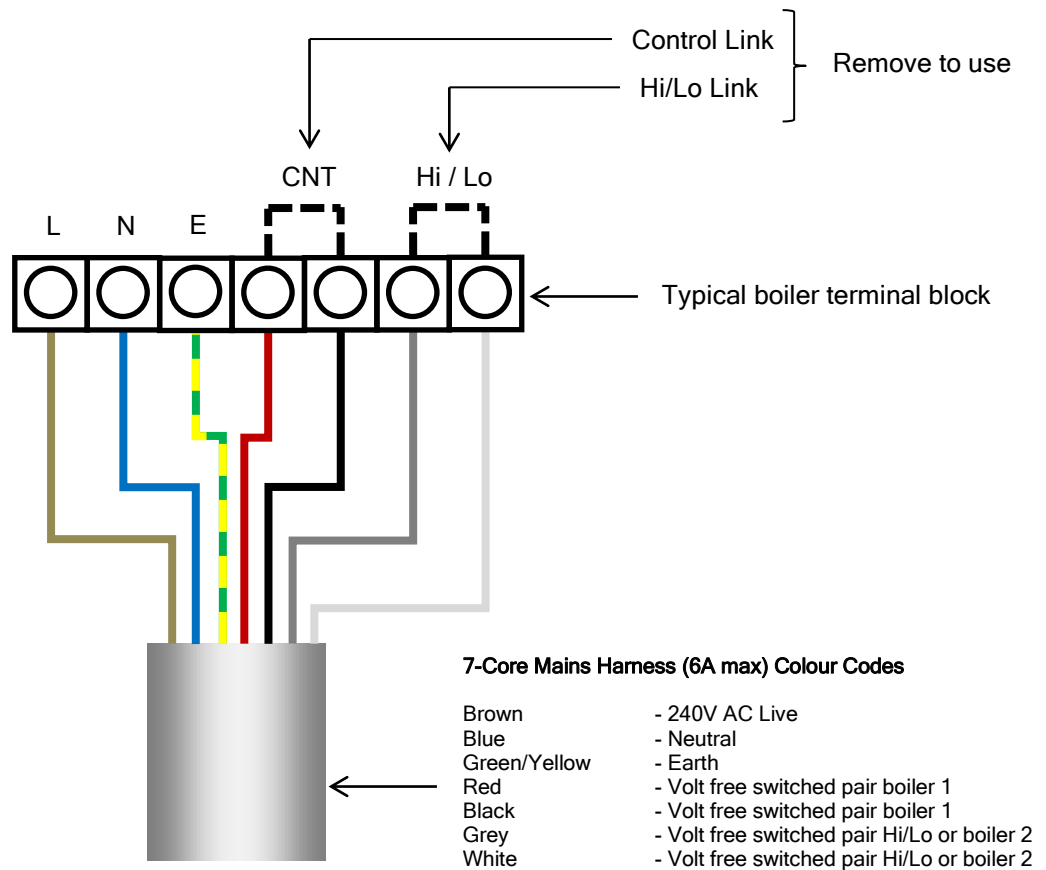

Note

If connecting to a single or non Hi/Lo boiler then the Hi/Lo control link will not be available and the grey and white cables will not be used.

If the control link connections are already in use by an existing external control then wire the red and black cables in series with one side of the existing control connection.

Connections when no control links are available

Some older boilers may not have external control links as in Fig 1. If the boiler wiring consists of a boiler thermostat and gas/oil valve only, then the red and black cables may be wired directly in series with the mains supply to the boiler.

If the boiler has both a permanent and a switched supply then connect to the switched supply as shown in Fig 2.

If there is an existing switched live control connection (time clock) then wire in series with this connection as shown in Fig 3.

Fig 2. Typical Boiler Terminal Block Connections – permanent and switched live

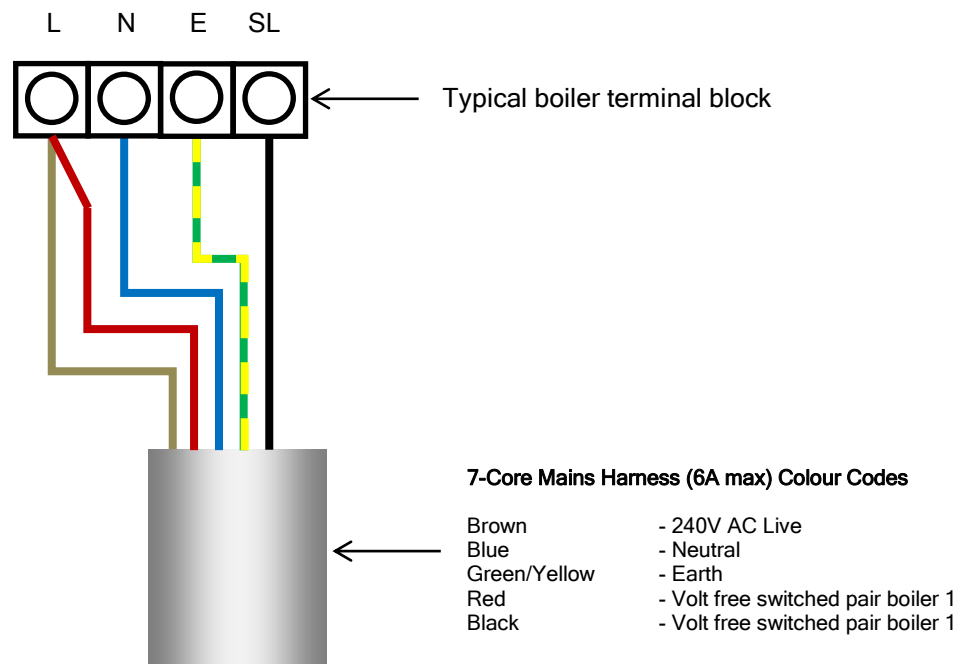
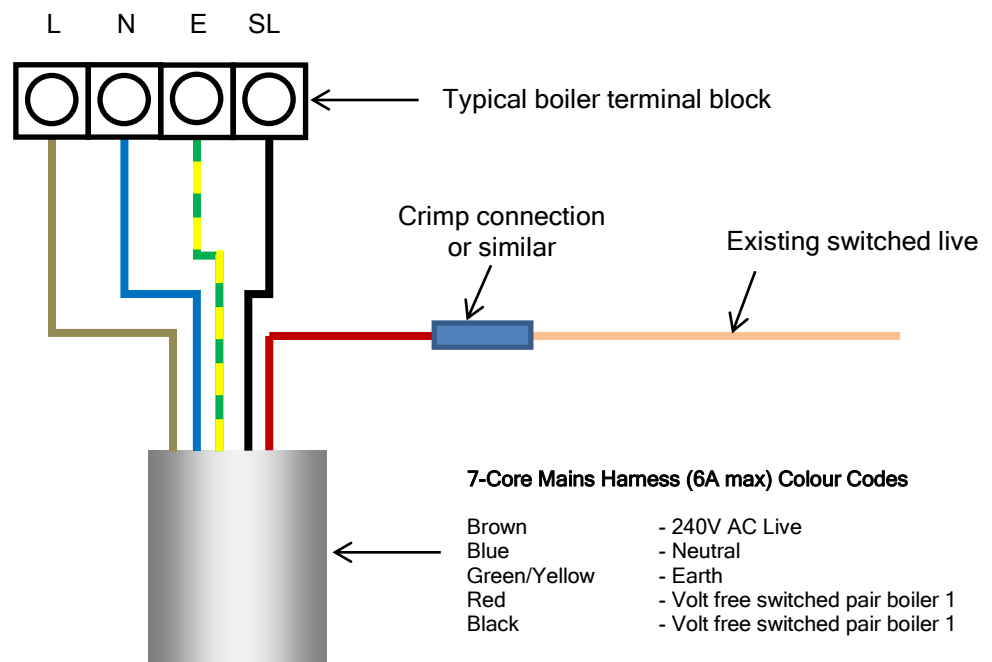
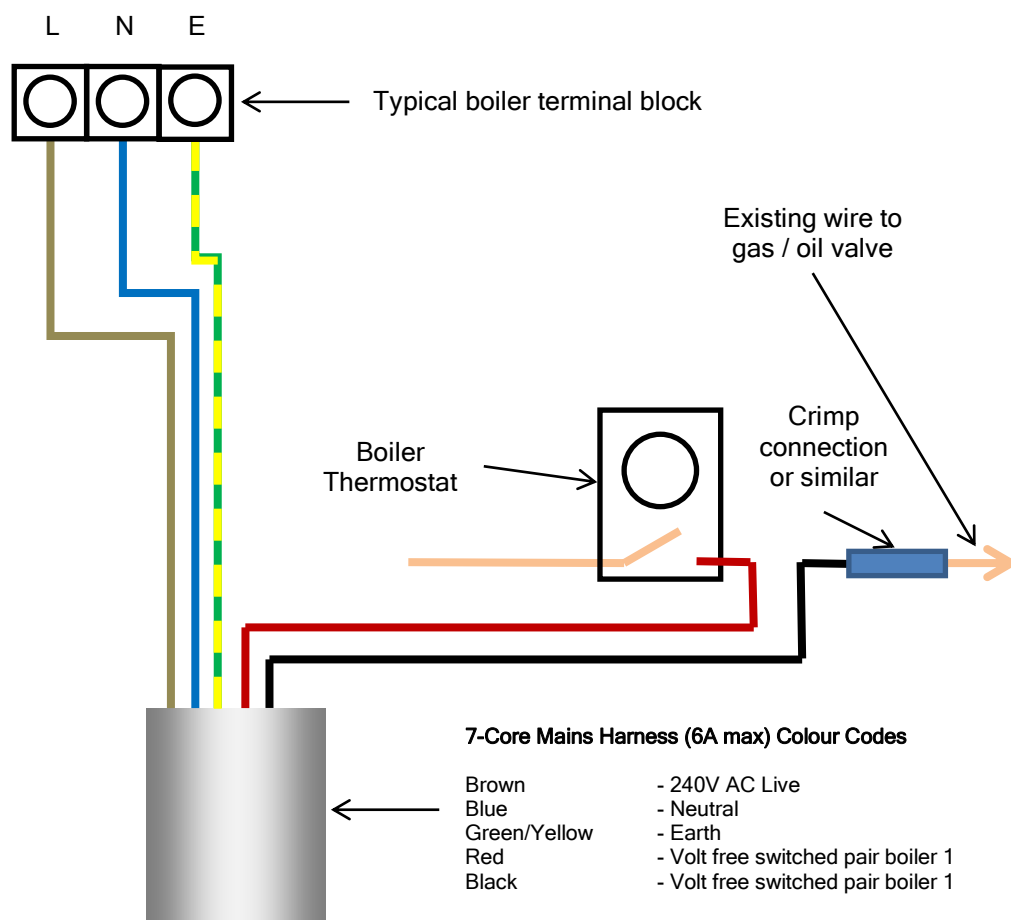

Fig 3. Typical Boiler Terminal Block Connections – with existing switched live



Another connection method for older boilers is, where practical, to wire in series with an existing boiler thermostat as shown in Fig 4.

Fig 4. Typical Boiler Terminal Block Connections – with existing boiler thermostat



Note

If connecting to a second or Hi/Lo boiler then wire the GREY and WHITE cables of the mains harness in series with the second boiler or Hi/Lo thermostat.

Wiring to a Twin / Dual Boiler System

When wiring the Boiler Management system to control two boilers the 7-core mains harness should be terminated in a junction box to allow convenient connections to each boiler and the mains supply.

Mount the controller ensuring that the sensors will reach the flow and return pipework, and the mains harness will reach the junction box.

A typical layout is shown in Fig 5.

Fig 5. Typical twin/dual boiler connections via junction box

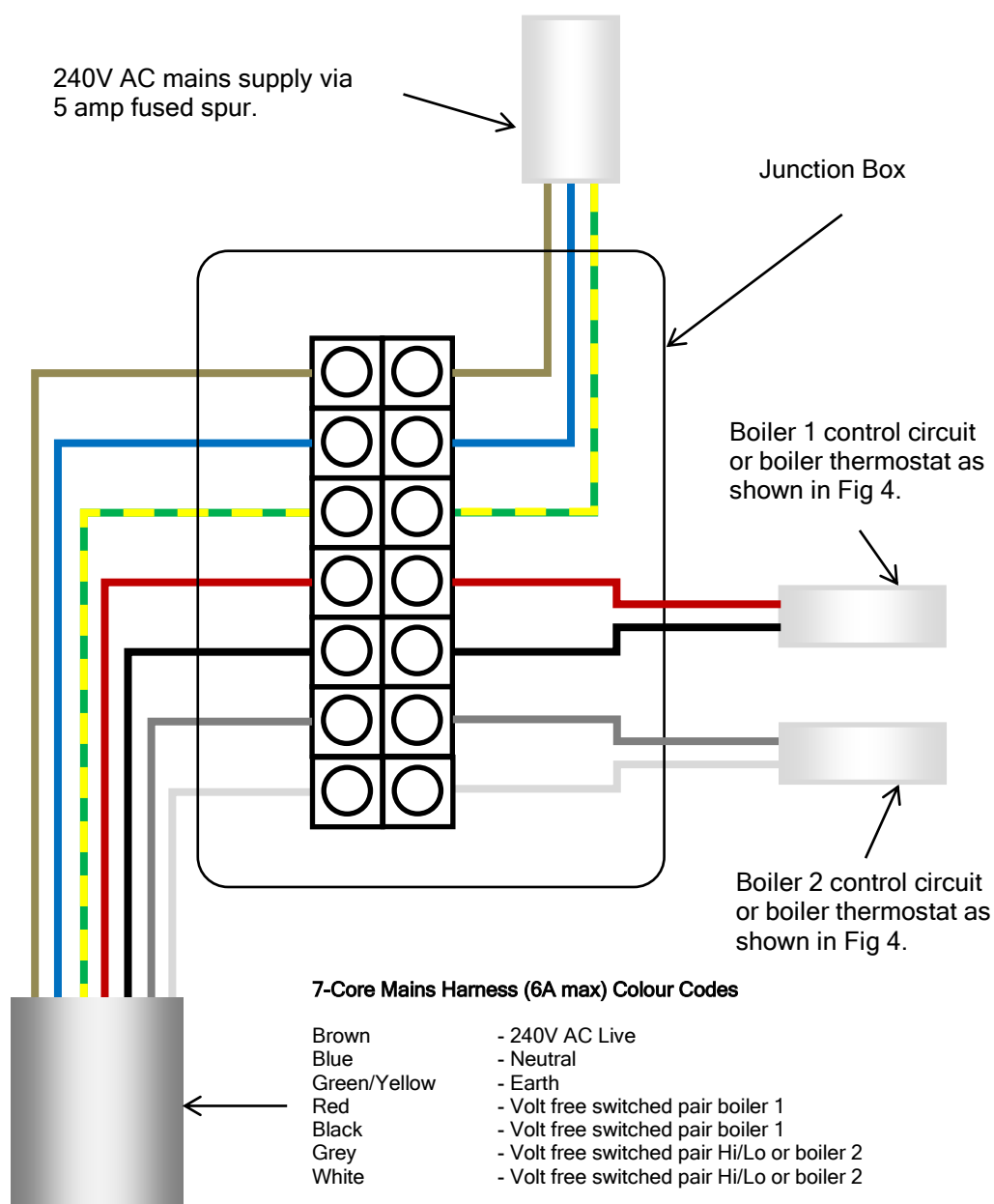

Installing the Sensors

Before installing the flow and return temperature sensors the flow and return pipework must be identified.

On conventional free standing boilers the flow pipe will exit the boiler near the top and the return pipe will enter the boiler near the bottom. If in doubt, locate the circulating pump and not the direction of water flow as indicated by the arrow stamped on the pump housing. If the arrow points away from the boiler then the pump is on the flow pipe. If the arrow points towards the boiler then the pump is on the return pipe, as shown in Fig 6.

Fig 6. Identifying the flow and return pipework

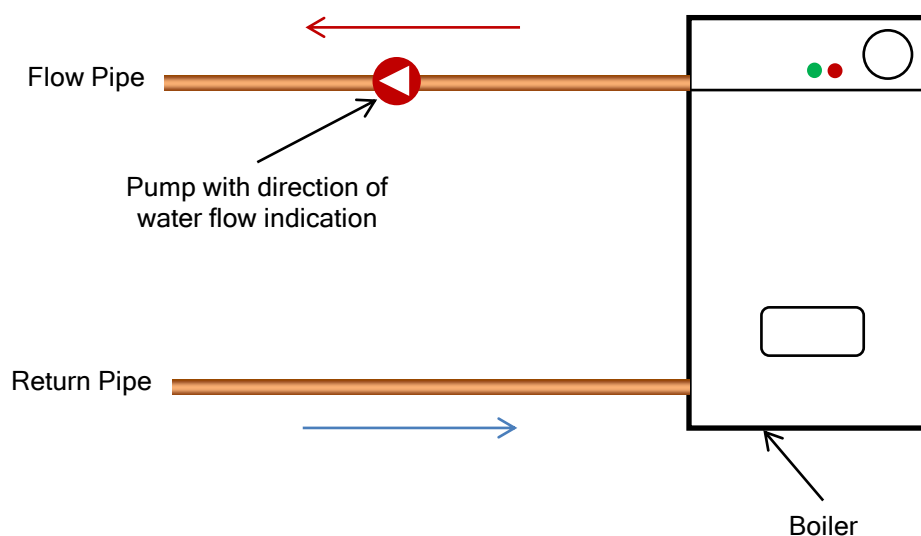

The Boiler Management system has two temperature sensors, one for outgoing flow pipe (red sensor) and one for the incoming return pipe (black sensor) of the heating system.

When the flow and return pipes have been correctly identified fix the red sensor firmly to the flow pipe using heat resistant cloth tape and in the same manner fix the black sensor to the return pipe. DO NOT use PVC tape or cable ties to secure the sensor to the pipes.

If the pipes are insulated with fibre glass or foam insulation then carefully remove a section to allow the sensors to be fitted directly to the pipework. Recover and secure with cable ties. If there is no pipe insulation then cover the sensors with the supplied foam sleeves and secure with cable ties. See Fig 7.

Fig 7. Attaching the sensors to the flow and return pipework

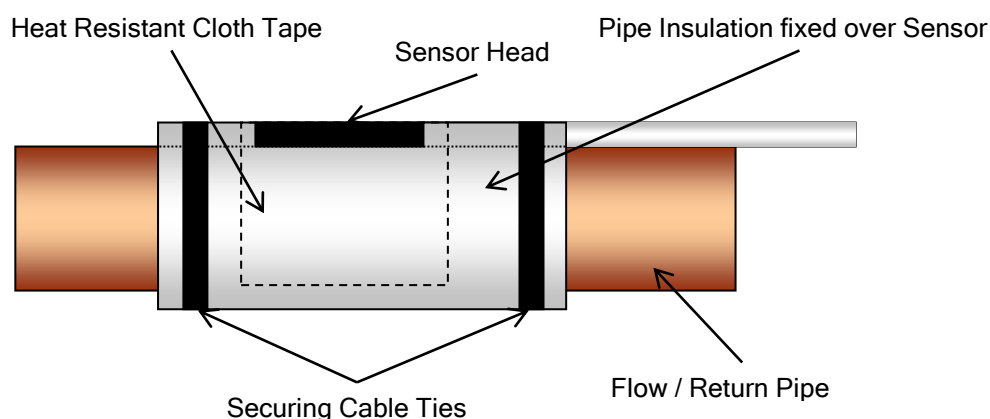

On twin/dual boiler installations the sensors should be fitted on the relevant common flow or common return pipe as shown in Fig 8.

Fig 8. Sensor positions on twin/dual boiler system

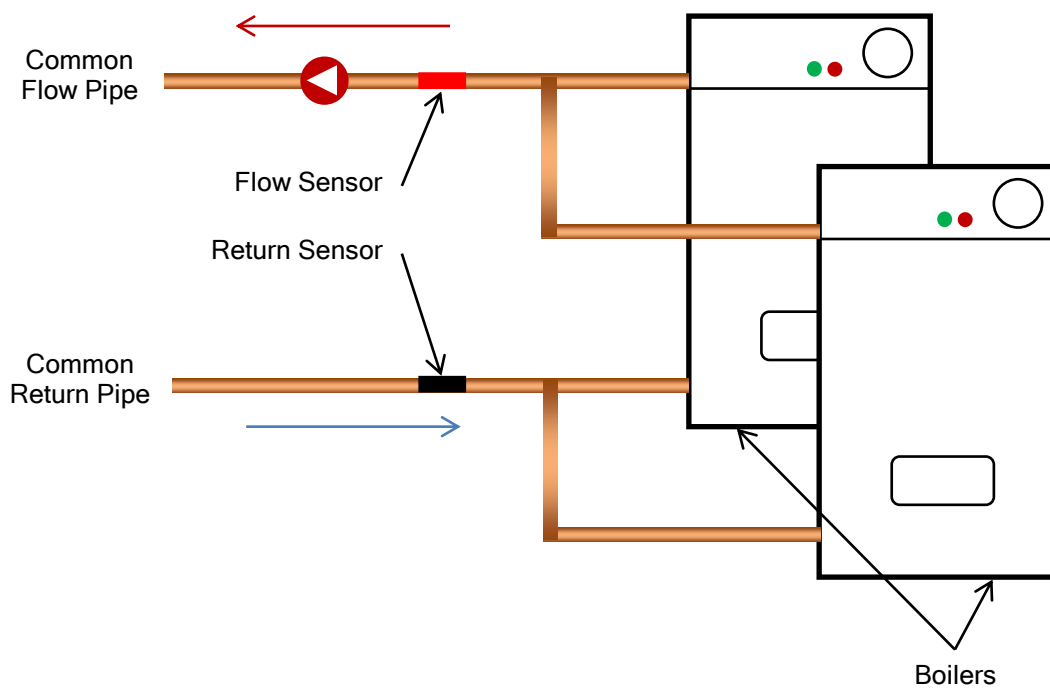

Commissioning

Before applying power re-check all wiring and sensor fixings.

The TEC VTR system has 10 programmable settings:

P1	CALENDAR	(Year/Month/Date/Day/Time)
P2	ON/OFF TIMES	(Up to 2 per day)
P3	TIMER MODE	(Once, Twice, Continuous)
P4	SELECT DAYS	(Everyday, Weekdays)
P5	MAX FLOW TEMP.	(30°C - 85°C)
P6	MIN FLOW TEMP.	(25°C - 85°C)
P7	SET LOAD RATIO	(0.5, 1.0, 1.5)
P8	SET ROTATION	(YES or NO)
P9	AUTO B.S.T.	(YES or NO)
P10	SET EXT LEVEL **	(0°C - 35°C)

** Only available when using the optional external temperature sensor.

Keypad Overview



PROGRAM

Used to enter Programming Mode from normal running mode, and to access change mode for the selected program.



SELECT

Used to cycle through the program list when in Programming Mode and to change program settings when in change mode.

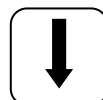

RETURN

Used to cycle through the program list when in Programming Mode and to change program settings when in change mode.



ENTER

Used to confirm a programming change and to exit from the Programming Mode.

Display Overview

Current day and time

Current Mode

- BOOST** - Initial start up boost or recovery from boilers off.
- FIRE (12)** - Boiler(s) commanded to fire (1, 2 or 1+2 not displayed if P7 set to No).
- TMP.SET** - Set point reached boiler(s) not firing.
- ECONOMY** - Economy period, boiler(s) not firing.
- BOILERS OFF** - Boilers off on time or external cut off temperature.

Calculated set point

This is the flow temperature at which point the boiler(s) will cut off.

When using the optional external sensor the set point will vary according to the outside temperature.

Current flow temperature

Current return temperature

Current external temperature

Only visible when using the optional external temperature sensor.

```

FIRE12 Mon10:15
S70 F68 R62 E12
  
```

Establishing the Heating System Maximum Flow Temp

1. Switch on the power to the Boiler Management system.
2. Set the Bypass Switch to the bypass position.

Allow the heating system to cycle twice at the normal winter setting of the boiler thermostat (see plant engineer, caretaker, maintenance manager etc to establish winter thermostat position).
3. When the boiler has cycled twice with the Boiler Management system in bypass, observe the actual flow temperature as shown on the display:

```

FIRE12 Mon10:15
S70 F68 R62 E12
  
```

This temperature should be set as the maximum flow temperature (P5) in the Boiler Management program as described later on in this manual.

The boiler thermostat should now be set to a higher setting to ensure correct operation of the Boiler Management system.

Programming the Boiler Management system



Entering Program Mode

To access the Program Mode on the Boiler Management system:

Hold  for a few seconds to access the program menu.
PROGRAM

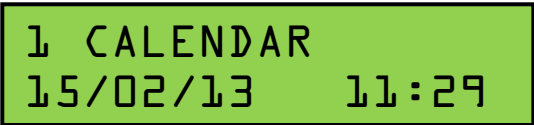
Release when the display changes to:
(If SET YEAR appears on the display you have held the button in for too long. Press E until the display returns to 1 CALENDAR.)



Use  and  to select the required program.
SELECT **RETURN**

1. Calendar

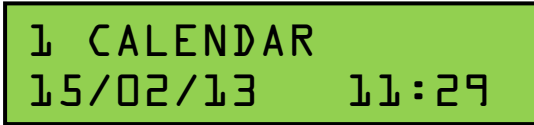



Press  to change display to:
PROGRAM





Use  and  to set the year.
SELECT **RETURN**



Press  to change display to:
ENTER





Use  and  to set the month.
SELECT **RETURN**

Press  to change display to: 
ENTER

Use  and  to set the date.
SELECT **RETURN**

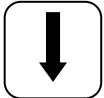
Press  to change display to: 
ENTER

Use  and  to set the hour.
SELECT **RETURN**

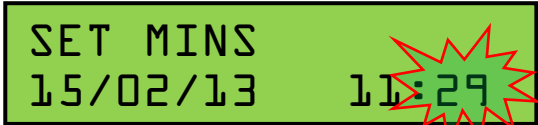
Press  to change display to: 
ENTER

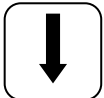
Use  and  to set the minutes.
SELECT **RETURN**

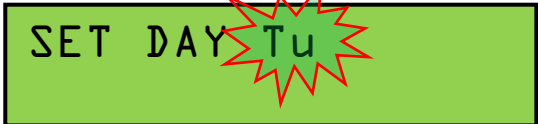
Press  to change display to: 
ENTER

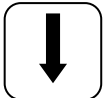
Use  and  to set the day.
SELECT **RETURN**

Press  to change display to:

SET TO B.S.T.
UP/DN TO CHANGE

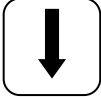
Use  and  to set BST or GMT as required.

SELECT

RETURN

Press  to confirm the program change and return to main menu.

ENTER

2. On/Off Times



2 ON/OFF TIMES

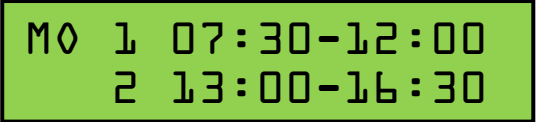

Press  to change display to:
PROGRAM





MO 1 07:30-12:00
2 13:00-16:30

There are two (2) programmable On/Off times per day.

All on/off times for the given day must be programmed in chronological order and fall within the same 24 hour period 00:00 to 23:59.

Use  and  to select the required day.
SELECT RETURN

Press  to enter programming mode for the selected day. This will also copy the previous day's on/off times into the current day.
PROGRAM





MO 1 07:30-12:00
* 2 13:00-16:30

Press  to accept times and choose another day or:
ENTER

Press  to change display to:
PROGRAM



SET HOUR
ON 1- 07:30

Use  and  to set the hour.
SELECT RETURN

Press  to change display to:
ENTER



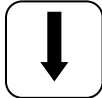

SET MINS
ON 1- 07:30

Use  and  to set the minutes.
SELECT **RETURN**

Press  to change display to:

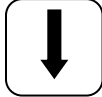
SET HOUR
OFF 1- 12:00

Use  and  to set the hour.
SELECT **RETURN**

Press  to change display to:

SET MINS
OFF 1- 12:00

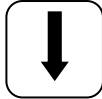
Use  and  to set the minutes.
SELECT **RETURN**

Press  to change display to:

SET HOUR
ON 2- 13:00

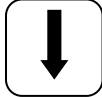
Use  and  to set the hour.
SELECT **RETURN**

Press  to change display to:

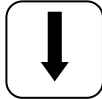

SET MINS
ON 2- 13:00

Use  and  to set the minutes.
SELECT **RETURN**

Press  to change display to:
ENTER





SET HOUR
OFF 2- 16:30

Use  and  to set the hour.
SELECT RETURN

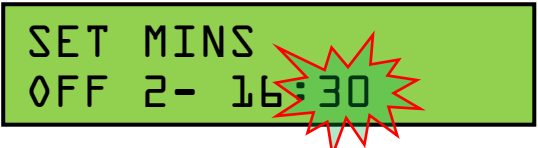
Press  to change display to:
ENTER





SET MINS
OFF 2- 16:30

Use  and  to set the minutes.
SELECT RETURN

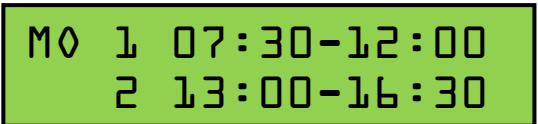
Press  to return display to:
ENTER



MO 1 07:30-12:00
2 13:00-16:30

Use  and  to select the required day and repeat above or...
SELECT RETURN

Press  to confirm the program changes and return to main menu.
ENTER

3. Timer Mode

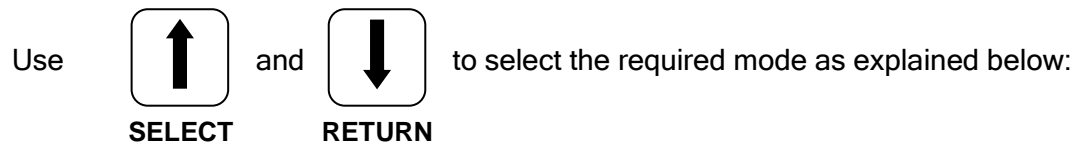
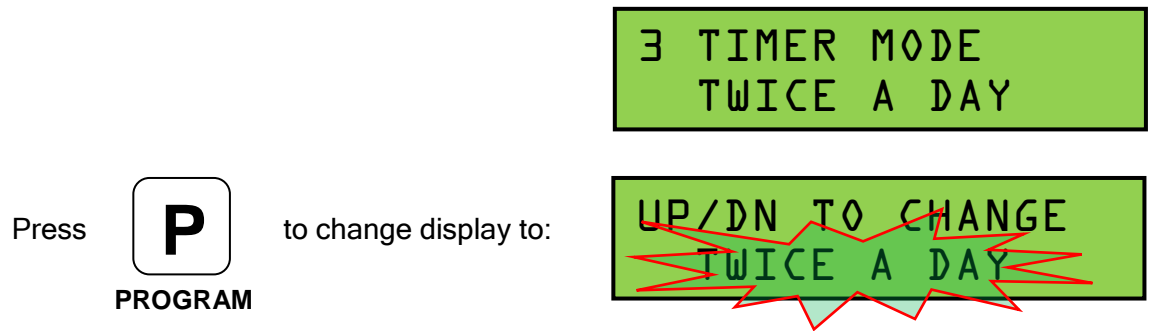

TWICE A DAY

The heating operates only during the two defined timed periods.

CONTINUOUS

The heating operates 24 hours a day irrespective of the programmed timed periods. This mode should be used if another control system (time clock, BMS etc) is managing the on/off times.

ONCE A DAY

The heating operates only in a single timed period between the first on time (ON 1) and the second off time (OFF 2).

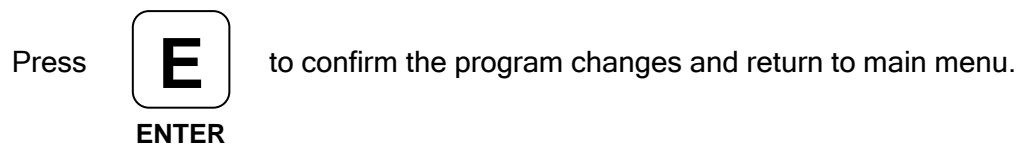



4. Select Days

4 SELECT DAYS
CURRNT EVERY DAY

Press  to change display to:
PROGRAM

UP/DN TO CHANGE
~~CURRNT EVERY DAY~~

Use  and  to select the required mode as explained below:
SELECT **RETURN**

EVERY DAY

The heating operates 7 days a week - Mon Tue Wed Thu Fri Sat Sun.

WEEK DAYS

The heating operates 5 days a week - Mon Tue Wed Thu Fri.

Press  to confirm the program changes and return to main menu.
ENTER

5. Maximum Flow Temperature



5 MAX FLOW TEMP
CURRENT 70

Press  to change display to:

PROGRAM

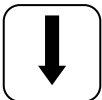

UP/DN TO CHANGE
CURRENT 70

Use  and  to select the required temperature.

SELECT

RETURN

This setting represents the maximum boiler output (flow) temperature.

When using the optional external sensor the maximum output will only occur during periods where the outside temperature is at 0°C or below.

During conditions above 0°C the boiler output temperature will scale based on the outside temperature and is represented by the calculated set point (S) on the display.

Press  to confirm the program changes and return to main menu.

ENTER

6. Minimum Flow Temperature

Press  to change display to:

PROGRAM

6 MIN FLOW TEMP
CURRENT 60

UP/DN TO CHANGE
CURRENT 60

Use  and  to select the required temperature.

SELECT **RETURN**

This setting represents the minimum boiler output (flow) temperature and should be set 10°C - 15°C below the maximum flow setting. Should the flow temperature fall to this level the boilers will fire.

When using the optional external sensor the calculated set point (S) as shown on the display will not fall below the minimum flow temperature setting.

Press  to confirm the program changes and return to main menu.

ENTER

7. Set Load Ratio

7 SET LOAD RATIO
CURRENT 1.0

Press  to change display to:

UP/DN TO CHANGE
CURRENT 1.0

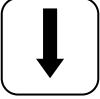
Use  and  to select the required ratio.

This setting determines the response of the boiler to the heating / hot water demand.

The normal setting is 1.0 and this should be sufficient in most circumstances.

If there is a high demand for hot water then a setting of 0.5 may be more appropriate.

On heating only systems which are oversized or cope well with the heating demand a setting of 1.5 may be used to achieve higher savings.



Press  to confirm the program changes and return to main menu.

8. Set Rotation

Press  to change display to:
PROGRAM

⌘ SET ROTATION
CURRENT YES

UP/DN TO CHANGE
CURRENT YES

Use  and  to select YES or NO as required.
SELECT RETURN

This setting should be set to YES when connecting to two individual boilers.

It should be set to NO** when connecting to a single boiler, a single hi/lo boiler or a two boiler installation where the lead boiler must never change.

When set to YES the lead boiler (first to fire) alternates each day to spread the work load more evenly across the two boilers.

In both instances the second stage/boiler will always fire approximately 3 minutes after the first.

** This is very important to ensure the correct operation of the heating system.



Press  to confirm the program changes and return to main menu.
ENTER

9. Auto B.S.T. (British Summer Time)

9 AUTO B.S.T.
CURRENT YES

Press  to change display to:
PROGRAM

UP/DN TO CHANGE
CURRENT YES

Use  and  to select YES or NO as required.
SELECT RETURN

This setting, when set to YES, automatically adjusts the current time by ± 1 hour to reflect the change from GMT to BST and vice versa.

The adjustment will take place on the final Sunday in March and the final Sunday in October.

If set to NO then no adjustment will occur.

Press  to confirm the program changes and return to main menu.
ENTER

10. Set External Level (when using the optional external temperature sensor)

Please note that this setting will only appear in the program menu when using the optional external temperature sensor.



10 SET EXT LEVEL
CURRENT 15

Press



to change display to:

PROGRAM



UP/DN TO CHANGE
CURRENT 15

Use



and

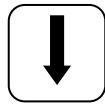

to select the required temperature.

SELECT

RETURN

This setting switches off the boilers once the outside temperature reaches the programmed level.

Press



to confirm the program changes and return to main menu.

ENTER

Using the Active / Bypass Switch

You should normally leave the active/bypass switch in the ACTIVE position to allow the correct operation of the TEC VTR system.

If a problem is suspected with either the control unit or the heating system then switch to the BYPASS position.

If the problem is resolved, leave the switch in this position and contact your installer. If the problem is still apparent, there is probably a fault elsewhere on the heating system and you should contact your installer or maintenance company.